

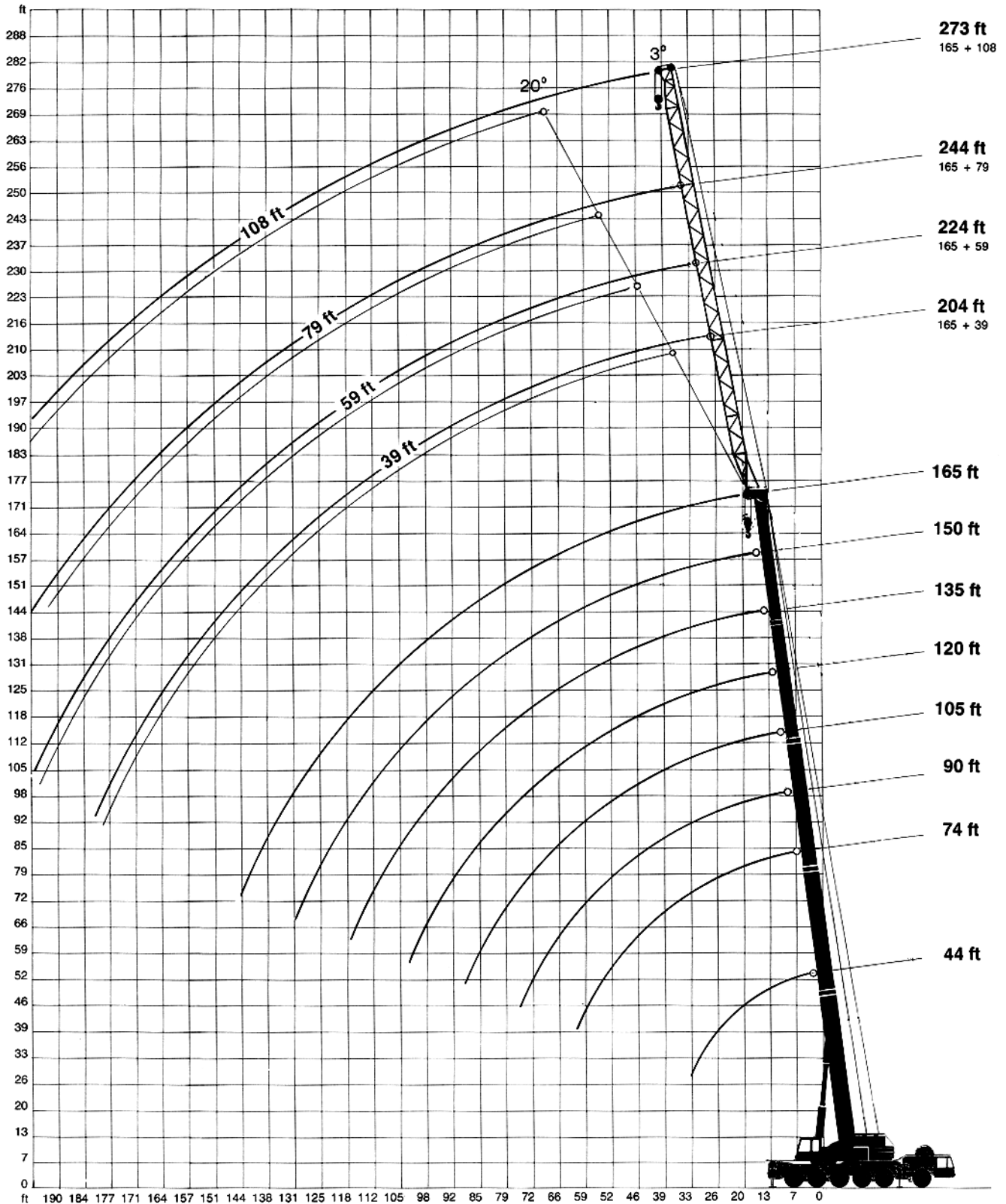

LIFTING CHARTS - All Terrain Cranes

DEMAG MODEL AC 615 - 250 TON CAPACITY

Main-Boom and Fixed Fly-Jib Working Ranges



STERLING CRANE

Main Boom Lifting Capacities

132,000 lb

360° 

85%

Radius	Main Boom							
	44 ft	74 ft	90 ft	105 ft	120 ft	135 ft	150 ft	165 ft
ft	1,000 lb	1,000 lb	1,000 lb	1,000 lb	1,000 lb	1,000 lb	1,000 lb	1,000 lb
9	500.0* **	-	-	-	-	-	-	-
10	423.2*	-	-	-	-	-	-	-
11	377.0*	-	-	-	-	-	-	-
13	344.0*	300.0*	-	-	-	-	-	-
15	313.0*	299.8*	-	-	-	-	-	-
16	288.8*	277.7*	263.0	-	-	-	-	-
19	253.5	249.1	249.1	200.0	-	-	-	-
23	224.8	219.8	217.3	187.3	150.0	-	-	-
26	194.8	194.8	194.8	176.1	142.4	120.0	-	-
29	174.8	174.8	174.8	164.9	132.2	114.8	95.0	-
33	<u>152.3</u>	154.7	154.8	154.7	122.3	109.7	89.9	71.0
39	-	128.7	128.3	131.4	102.3	96.1	83.5	69.0
46	-	106.2	105.8	108.9	88.6	83.5	76.0	67.4
52	-	89.9	89.2	92.1	77.3	75.0	68.5	61.0
59	-	<u>77.1</u>	76.2	79.1	68.5	66.1	62.4	54.9
65	-	-	<u>66.3</u>	<u>68.7</u>	62.4	58.6	56.2	48.7
72	-	-	57.1	60.0	<u>56.2</u>	53.5	51.1	45.0
78	-	-	-	52.0	49.3	48.7	47.4	41.2
85	-	-	-	45.8	42.7	<u>45.0</u>	43.6	37.4
92	-	-	-	39.9	37.7	<u>39.9</u>	39.9	33.7
98	-	-	-	-	32.8	35.2	<u>36.1</u>	31.0
105	-	-	-	-	28.8	31.0	33.0	28.6
111	-	-	-	-	-	27.5	29.5	26.2
118	-	-	-	-	-	24.7	26.4	<u>24.9</u>
124	-	-	-	-	-	-	23.6	22.9
131	-	-	-	-	-	-	21.1	20.2
138	-	-	-	-	-	-	-	18.0
144	-	-	-	-	-	-	-	16.1
151	-	-	-	-	-	-	-	-
157	-	-	-	-	-	-	-	-
164	-	-	-	-	-	-	-	-

* with heavy-lift accessories

** 2x10° over rear

The capacities above the parting line are based upon the structural strength.

The ratings below the parting line are based on stability for the percentage of tipping load indicated.

STERLING CRANE

Main Boom Lifting Capacities

88,000 lb		360° 							85%
Radius		Main Boom							
ft	44 ft 1,000 lb	74 ft 1,000 lb	90 ft 1,000 lb	105 ft 1,000 lb	120 ft 1,000 lb	135 ft 1,000 lb	150 ft 1,000 lb	165 ft 1,000 lb	
9	450.0*	-	-	-	-	-	-	-	
10	423.2*	-	-	-	-	-	-	-	
11	377.0*	-	-	-	-	-	-	-	
13	344.4*	300.0*	-	-	-	-	-	-	
15	313.0*	299.8*	-	-	-	-	-	-	
16	288.0*	277.7*	263.0	-	-	-	-	-	
19	246.9*	244.7	244.7	200.0	-	-	-	-	
23	211.6	210.0	209.8	187.4	150.0	-	-	-	
26	184.0	182.3	182.0	176.1	142.4	120.0	-	-	
29	161.1	159.6	158.9	162.2	132.2	114.8	95.0	-	
33	<u>141.9</u>	140.2	140.0	143.0	122.3	109.7	89.9	71.0	
39	-	<u>112.0</u>	<u>111.7</u>	<u>114.6</u>	102.2	96.1	83.5	69.0	
46	-	89.2	88.8	92.6	<u>88.6</u>	<u>83.5</u>	76.0	67.4	
52	-	71.4	70.7	74.0	<u>71.4</u>	<u>74.0</u>	68.5	61.0	
59	-	58.4	57.7	61.0	58.4	60.8	<u>62.4</u>	54.9	
65	-	-	48.0	51.1	48.2	50.9	52.9	<u>48.7</u>	
72	-	-	40.5	43.4	40.5	43.2	45.2	44.3	
78	-	-	-	37.4	34.4	36.8	38.5	38.1	
85	-	-	-	32.1	29.1	31.5	33.7	32.8	
92	-	-	-	27.7	24.7	27.1	29.1	28.4	
98	-	-	-	-	20.9	23.1	25.1	24.4	
105	-	-	-	-	17.6	19.8	21.8	21.1	
111	-	-	-	-	-	17.2	18.9	18.0	
118	-	-	-	-	-	14.5	16.3	15.6	
124	-	-	-	-	-	-	14.3	13.4	
131	-	-	-	-	-	-	12.3	11.6	
138	-	-	-	-	-	-	-	9.9	
144	-	-	-	-	-	-	-	8.3	
151	-	-	-	-	-	-	-	-	
157	-	-	-	-	-	-	-	-	
164	-	-	-	-	-	-	-	-	
170	-	-	-	-	-	-	-	-	
177	-	-	-	-	-	-	-	-	
184	-	-	-	-	-	-	-	-	
190	-	-	-	-	-	-	-	-	

* with heavy-lift accessories

The capacities above the parting line are based upon the structural strength.

The ratings below the parting line are based on stability for the percentage of tipping load indicated.

STERLING CRANE

Main Boom Lifting Capacities

57,000 lb

360° 

85%

Radius	Main Boom							
	44 ft	74 ft	90 ft	105 ft	120 ft	135 ft	150 ft	165 ft
ft	1,000 lb	1,000 lb	1,000 lb	1,000 lb	1,000 lb	1,000 lb	1,000 lb	1,000 lb
9	-	-	-	-	-	-	-	-
10	410.0*	-	-	-	-	-	-	-
11	363.7*	-	-	-	-	-	-	-
13	323.8*	285.0*	-	-	-	-	-	-
15	298.0*	274.0	-	-	-	-	-	-
16	269.0	259.0	250.0	-	-	-	-	-
19	229.6	228.4	227.9	190.0	-	-	-	-
23	195.5	194.0	193.5	181.8	145.0	-	-	-
26	166.9	165.4	164.9	168.4	134.5	115.0	-	-
29	145.0	143.5	143.0	146.2	124.5	110.8	90.0	-
33	<u>127.3</u>	<u>125.3</u>	<u>125.0</u>	<u>128.8</u>	<u>109.6</u>	<u>104.6</u>	84.7	70.0
39	-	90.2	90.0	93.6	90.6	93.6	<u>79.7</u>	67.2
46	-	68.5	68.2	71.7	68.7	71.5	<u>72.2</u>	<u>64.7</u>
52	-	54.0	53.5	56.8	54.0	56.8	58.8	58.0
59	-	43.6	43.0	46.0	43.3	45.8	48.0	47.3
65	-	-	34.8	38.1	35.1	37.8	39.8	39.1
72	-	-	28.4	31.6	28.6	31.1	33.3	32.6
78	-	-	-	26.4	23.1	25.9	27.9	27.1
85	-	-	-	21.9	18.6	21.1	23.4	22.6
92	-	-	-	18.1	14.9	17.4	19.4	18.6
98	-	-	-	-	11.9	14.2	16.2	15.4
105	-	-	-	-	9.2	11.7	13.4	12.7
111	-	-	-	-	-	9.2	11.2	10.4
118	-	-	-	-	-	7.2	9.2	8.2
124	-	-	-	-	-	-	7.4	6.4
131	-	-	-	-	-	-	5.7	4.9
138	-	-	-	-	-	-	-	3.4
144	-	-	-	-	-	-	-	2.5
151	-	-	-	-	-	-	-	-
157	-	-	-	-	-	-	-	-
164	-	-	-	-	-	-	-	-
170	-	-	-	-	-	-	-	-
177	-	-	-	-	-	-	-	-
184	-	-	-	-	-	-	-	-
190	-	-	-	-	-	-	-	-

* with heavy-lift accessories

The capacities above the parting line are based upon the structural strength.

The ratings below the parting line are based on stability for the percentage of tipping load indicated.

STERLING CRANE

Main Boom Lifting Capacities

26,500 lb		360° 							85%
Radius		Main Boom							
ft	44 ft 1,000 lb	74 ft 1,000 lb	90 ft 1,000 lb	105 ft 1,000 lb	120 ft 1,000 lb	135 ft 1,000 lb	150 ft 1,000 lb	165 ft 1,000 lb	
9	-	-	-	-	-	-	-	-	
10	390.0*	-	-	-	-	-	-	-	
11	339.5*	-	-	-	-	-	-	-	
13	299.7*	273.0	-	-	-	-	-	-	
15	266.7	264.5	-	-	-	-	-	-	
16	240.3	238.0	235.0	-	-	-	-	-	
19	198.4	196.8	196.6	185.0	-	-	-	-	
23	165.1	163.8	163.3	166.6	135.0	-	-	-	
26	132.2	130.7	130.5	135.3	131.6	112.0	-	-	
29	104.2	102.7	102.5	106.9	103.3	107.3	85.0	-	
33	85.0	83.5	83.3	87.0	84.2	87.0	79.8	62.0	
39	-	58.4	58.2	61.9	58.8	61.9	64.1	57.3	
46	-	42.3	42.1	45.4	42.5	45.4	47.3	46.7	
52	-	31.9	31.3	34.6	31.9	34.4	36.3	35.7	
59	-	24.4	23.8	26.8	24.4	26.6	28.6	28.0	
65	-	-	18.3	21.1	18.7	20.9	22.9	22.0	
72	-	-	14.1	16.9	14.3	16.7	18.3	17.6	
78	-	-	-	13.4	10.5	13.0	14.5	14.1	
85	-	-	-	10.5	7.5	9.9	11.9	11.2	
92	-	-	-	7.9	4.6	7.0	9.2	8.3	
98	-	-	-	-	2.4	4.6	6.6	5.9	
105	-	-	-	-	-	2.6	4.6	3.9	
111	-	-	-	-	-	-	2.8	2.2	
118	-	-	-	-	-	-	-	-	
124	-	-	-	-	-	-	-	-	
131	-	-	-	-	-	-	-	-	
138	-	-	-	-	-	-	-	-	
144	-	-	-	-	-	-	-	-	
151	-	-	-	-	-	-	-	-	
157	-	-	-	-	-	-	-	-	
164	-	-	-	-	-	-	-	-	
170	-	-	-	-	-	-	-	-	
177	-	-	-	-	-	-	-	-	
184	-	-	-	-	-	-	-	-	
190	-	-	-	-	-	-	-	-	

* with heavy-lift accessories

The capacities above the parting line are based upon the structural strength.

The ratings below the parting line are based on stability for the percentage of tipping load indicated.

STERLING CRANE

Main Boom Lifting Capacities

0 lb		360° 							85%
Radius		Main Boom							
	44 ft	74 ft	90 ft	105 ft	120 ft	135 ft	150 ft	165 ft	
ft	1,000 lb	1,000 lb	1,000 lb	1,000 lb	1,000 lb	1,000 lb	1,000 lb	1,000 lb	
9	-	-	-	-	-	-	-	-	
10	325.0*	-	-	-	-	-	-	-	
11	280.0*	-	-	-	-	-	-	-	
13	246.5	230.0	-	-	-	-	-	-	
15	220.4	220.4	-	-	-	-	-	-	
16	200.6	199.3	200.0	-	-	-	-	-	
19	<u>158.7</u>	<u>157.4</u>	<u>157.1</u>	<u>155.0</u>	-	-	-	-	
23	111.1	109.5	109.5	114.4	<u>110.0</u>	-	-	-	
26	82.0	80.4	80.4	84.6	81.3	85.0	-	-	
29	61.9	60.4	60.4	64.6	61.3	64.6	67.0	-	
33	48.5	46.9	46.7	50.4	47.4	50.4	52.9	52.0	
39	-	30.2	30.0	33.3	30.6	33.0	35.2	34.6	
46	-	20.5	20.0	23.1	20.7	22.9	24.9	24.2	
52	-	14.1	13.6	16.3	14.1	16.3	18.0	17.4	
59	-	9.2	8.8	11.6	9.2	11.4	13.2	12.5	
65	-	-	4.8	7.9	5.0	7.7	9.7	9.0	
72	-	-	2.0	4.8	2.0	4.4	6.4	5.7	
78	-	-	-	2.2	-	1.7	4.4	3.0	
85	-	-	-	-	-	-	-	-	
92	-	-	-	-	-	-	-	-	
98	-	-	-	-	-	-	-	-	
105	-	-	-	-	-	-	-	-	
111	-	-	-	-	-	-	-	-	
118	-	-	-	-	-	-	-	-	
124	-	-	-	-	-	-	-	-	
131	-	-	-	-	-	-	-	-	
138	-	-	-	-	-	-	-	-	
144	-	-	-	-	-	-	-	-	
151	-	-	-	-	-	-	-	-	
157	-	-	-	-	-	-	-	-	
164	-	-	-	-	-	-	-	-	
170	-	-	-	-	-	-	-	-	
177	-	-	-	-	-	-	-	-	
184	-	-	-	-	-	-	-	-	
190	-	-	-	-	-	-	-	-	

* with heavy-lift accessories

The capacities above the parting line are based upon the structural strength.

The ratings below the parting line are based on stability for the percentage of tipping load indicated.

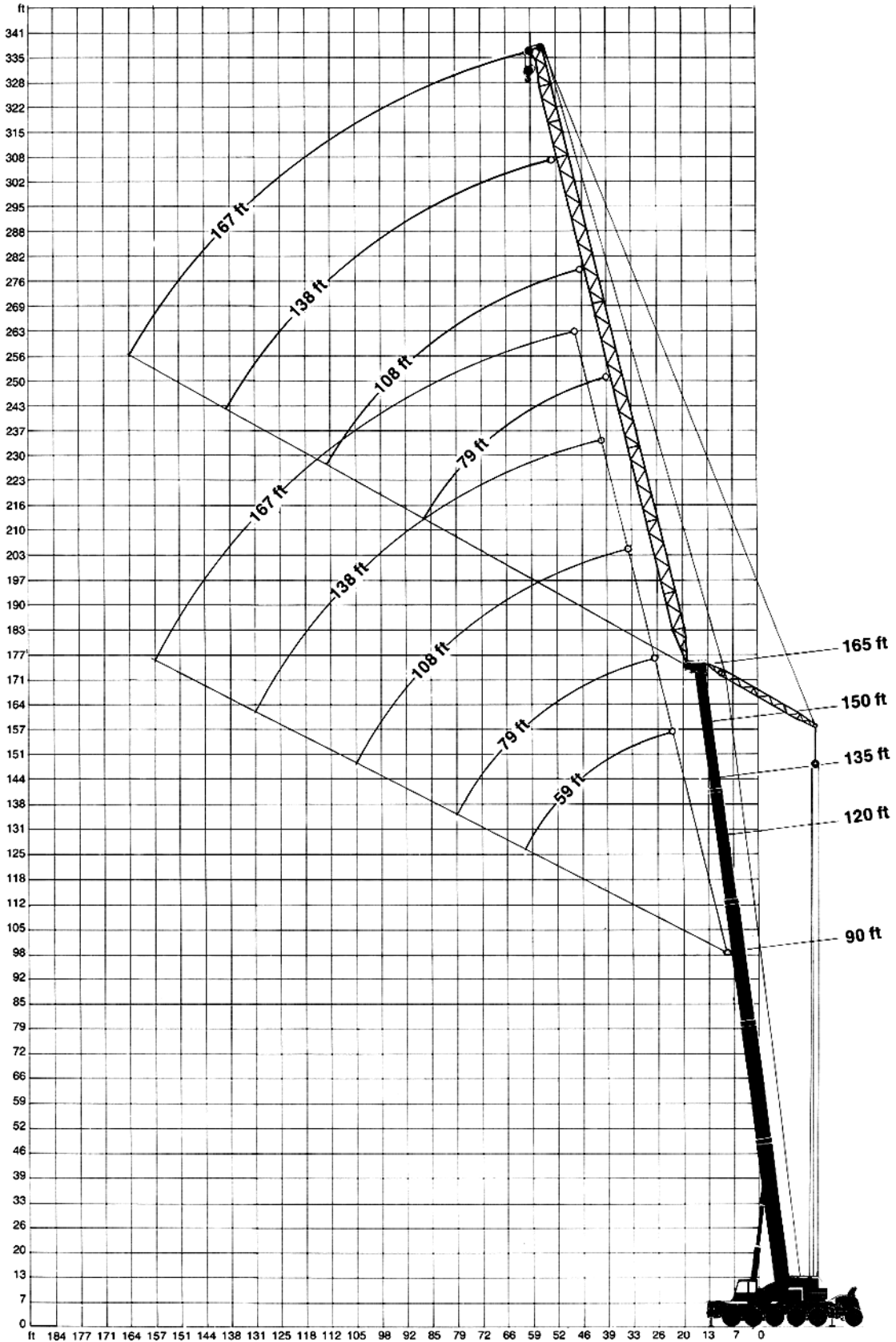

STERLING CRANE

Luffing Fly-Jib Working Ranges



STERLING CRANE

Lifting Capacities on Luffing Fly Jib

88,000 lb							88,000 lb					
360° 							360° 					
Luffing Fly Jib							Luffing Fly Jib					
Boom	Radius	59 ft (1)	79 ft	108 ft	138 ft	167 ft	Boom	Radius	79 ft	108 ft	138 ft	167 ft
	ft	1,000 lb	1,000 lb	1,000 lb	1,000 lb	1,000 lb		ft	1,000 lb	1,000 lb	1,000 lb	1,000 lb
90 ft	33	92.6	-	-	-	-	135 ft	46	35.2	-	-	-
	39	90.3	66.0	-	-	-		52	35.2	-	-	-
	46	81.5	66.0	49.8	-	-		59	35.2	26.4	-	-
	52	68.3	66.0	49.8	-	-		65	35.2	26.4	19.4	-
	59	<u>52.9</u>	58.6	49.8	37.4	-		72	35.2	26.4	19.4	10.1
	65	-	50.9	49.8	35.7	25.5		79	34.1	26.4	19.4	10.1
	72	-	44.0	46.9	34.3	25.5		85	<u>33.0</u>	26.4	19.4	10.1
	79	-	<u>33.9</u>	44.0	32.6	24.7		92	-	25.8	19.4	10.1
	85	-	-	38.1	30.8	23.5		98	-	24.9	18.5	10.1
	92	-	-	32.6	29.3	22.2		105	-	24.2	18.0	10.1
	98	-	-	27.5	27.7	21.1		111	-	<u>22.4</u>	17.6	10.1
	105	-	-	<u>22.0</u>	26.4	20.0		118	-	-	17.4	10.1
	111	-	-	-	24.9	18.7		124	-	-	16.9	10.1
	118	-	-	-	22.0	17.2		131	-	-	16.7	10.1
	124	-	-	-	18.9	16.1		138	-	-	<u>16.0</u>	10.1
	131	-	-	-	<u>15.4</u>	15.4		144	-	-	-	10.1
	138	-	-	-	-	15.0		151	-	-	-	10.1
	144	-	-	-	-	14.5		157	-	-	-	10.1
	151	-	-	-	-	12.3		164	-	-	-	<u>10.1</u>
	157	-	-	-	-	10.1						
164	-	-	-	-	<u>7.9</u>							
120 ft	39	59.5	-	-	-	-	52	28.0	-	-	-	-
	46	58.4	48.5	-	-	-	59	27.7	20.2	-	-	-
	52	56.4	48.5	-	-	-	65	27.5	20.2	13.2	-	-
	59	55.1	47.3	34.0	-	-	72	27.3	20.2	13.2	-	-
	65	<u>46.7</u>	45.2	34.0	25.0	17.0	79	26.9	20.2	13.2	7.7	
	72	-	42.9	34.0	25.0	17.0	85	<u>26.4</u>	20.2	13.2	7.7	
	79	-	40.7	33.0	25.0	17.0	92	-	20.2	13.2	7.7	
	85	-	<u>30.6</u>	31.9	25.0	17.0	98	-	20.2	13.2	7.7	
	92	-	-	30.8	24.2	17.0	105	-	20.2	13.2	7.7	
	98	-	-	29.7	23.1	17.0	111	-	<u>18.7</u>	13.2	7.7	
	105	-	-	26.0	22.2	17.0	118	-	-	13.2	7.7	
	111	-	-	<u>20.7</u>	21.6	17.0	124	-	-	13.2	7.7	
	118	-	-	-	20.7	16.3	131	-	-	13.2	7.7	
	124	-	-	-	19.8	15.6	138	-	-	12.7	7.7	
	131	-	-	-	18.0	15.0	144	-	-	<u>12.3</u>	7.7	
	138	-	-	-	<u>14.7</u>	14.3	151	-	-	-	7.7	
	144	-	-	-	-	13.4	157	-	-	-	7.7	
	151	-	-	-	-	12.7	164	-	-	-	7.7	
	157	-	-	-	-	11.9	170	-	-	-	<u>6.6</u>	
	164	-	-	-	-	<u>9.7</u>						

(1) Hook Block with a min. weight of 2,500 lb required !

STERLING CRANE

Lifting Capacities on Luffing Fly Jib

88,000 lb		360°  75%			
Luffing Fly Jib					
Boom	Radius	79 ft	108 ft	138 ft	167 ft
	ft	1,000 lb	1,000 lb	1,000 lb	1,000 lb
	52	18.7	-	-	-
	59	18.7	14.3	-	-
	65	18.7	14.3	8.6	-
	72	18.7	14.3	8.6	-
	79	18.7	14.3	8.6	3.9
	85	<u>18.7</u>	14.3	8.6	3.9
	92	-	14.3	8.6	3.9
	98	-	14.3	8.6	3.9
165 ft	105	-	14.3	8.6	3.9
	111	-	14.3	8.6	3.9
	118	-	<u>14.3</u>	8.6	3.9
	124	-	-	8.6	3.9
	131	-	-	8.6	3.9
	138	-	-	8.6	3.9
	144	-	-	<u>8.6</u>	3.9
	151	-	-	-	3.9
	157	-	-	-	3.9
	164	-	-	-	3.9
	170	-	-	-	<u>3.9</u>

Lifting Capacities on Fixed Fly Jib (3°)

88,000 lb		360°  85%			
Fixed Fly Jib					
Boom	Radius	39 ft	59 ft	79 ft	108 ft
	ft	1,000 lb	1,000 lb	1,000 lb	1,000 lb
	39	37.5	-	-	-
	46	37.2	-	-	-
	52	35.7	21.5	-	-
	59	33.9	21.5	17.0	-
	65	32.4	20.7	16.9	11.5
	72	30.4	19.4	15.8	11.4
	78	29.1	18.3	15.2	11.4
	85	27.3	17.4	14.3	10.8
	92	25.5	16.7	13.6	10.3
	98	<u>24.2</u>	15.6	13.0	9.9
165 ft	111	20.0	14.1	11.6	8.8
	124	15.0	13.0	10.5	8.1
	138	11.0	10.3	9.7	7.0
	151	7.9	7.0	8.1	6.6
	164	5.3	4.6	5.5	5.9
	177	3.0	<u>2.8</u>	<u>3.3</u>	3.9
	190	-	-	-	<u>2.0</u>
	203	-	-	-	-
	216	-	-	-	-
	229	-	-	-	-

Lifting Capacities on Fixed Fly Jib (3°)

57,000 lb		360°  85%			
Fixed Fly Jib					
Boom	Radius	39 ft	59 ft	79 ft	108 ft
	ft	1,000 lb	1,000 lb	1,000 lb	1,000 lb
	39	37.5	-	-	-
	46	37.2	-	-	-
	52	35.7	21.5	-	-
	59	33.9	21.5	17.0	-
	65	32.4	20.7	16.9	11.5
	72	30.4	19.4	15.8	11.4
	78	<u>29.1</u>	18.3	15.2	11.4
	85	25.1	17.4	14.3	10.8
	92	20.7	16.7	13.6	10.3
	98	17.6	<u>15.6</u>	13.0	9.9
165 ft	111	12.1	11.4	<u>11.6</u>	8.8
	124	7.9	7.5	<u>8.3</u>	<u>8.1</u>
	138	4.6	4.1	5.0	5.9
	151	2.2	-	2.4	3.0
	164	-	-	-	-
	177	-	-	-	-
	190	-	-	-	-
	203	-	-	-	-
	216	-	-	-	-
	229	-	-	-	-

Duties for fixed fly jib with 20° offset upon request.

The capacities above the parting line are based upon the structural strength.

The ratings below the parting line are based on stability for the percentage of tipping load indicated.

STERLING CRANE

Working Speeds (infinitely variable)

Units	Normal	High Speed	Rope Pull, Single Line	Length of Hoist Rope
Main Hoist	157 ft/min	512 ft/min	113 kN	1050 ft
Secondary Hoist	138 ft/min	512 ft/min	113 kN	722 ft
Slewing	max. 2.3 RPM			
Telescoping Speed 44 -135 ft	130 s			
Boom Elevation from -2° to 82°	100 s			

Carrier Performance

Travel Speed	0 - 55 m.p.h.
Gradeability in Travel Order	max. 60%

Hook Block/Crane Hook

Type	Capacity 85%	Number of Sheaves	Number of Lines	Weight	»B«
200/9	500,000 lb	9	14/18*/20*	3,970 lb	8 ft
125/5	270,000 lb	5	11	3,086 lb	8 ft
100/3	175,000 lb	3	7	2,536 lb	8 ft
40/1	75,000 lb	1	3	1,676 lb	8 ft
12.5	25,000 lb	Crane Hook	1	772 lb	6 ft

* with heavy-lift accessories

Crane-Capacity Notes

Crane operation subject to computer charts only!

Gross capacities do not exceed 85% of tipping load (75% on Luffing Fly Jib).

The weights of hooks block, and all other load-handling accessories are considered part of the load.

Crane can still operate safely up to a Wind Force of 5% beaufort scale (29.5 ft or 20 mph) and a Wind Speed of 50.85 ft or 35 mph.

STERLING CRANE

DIMENSIONS

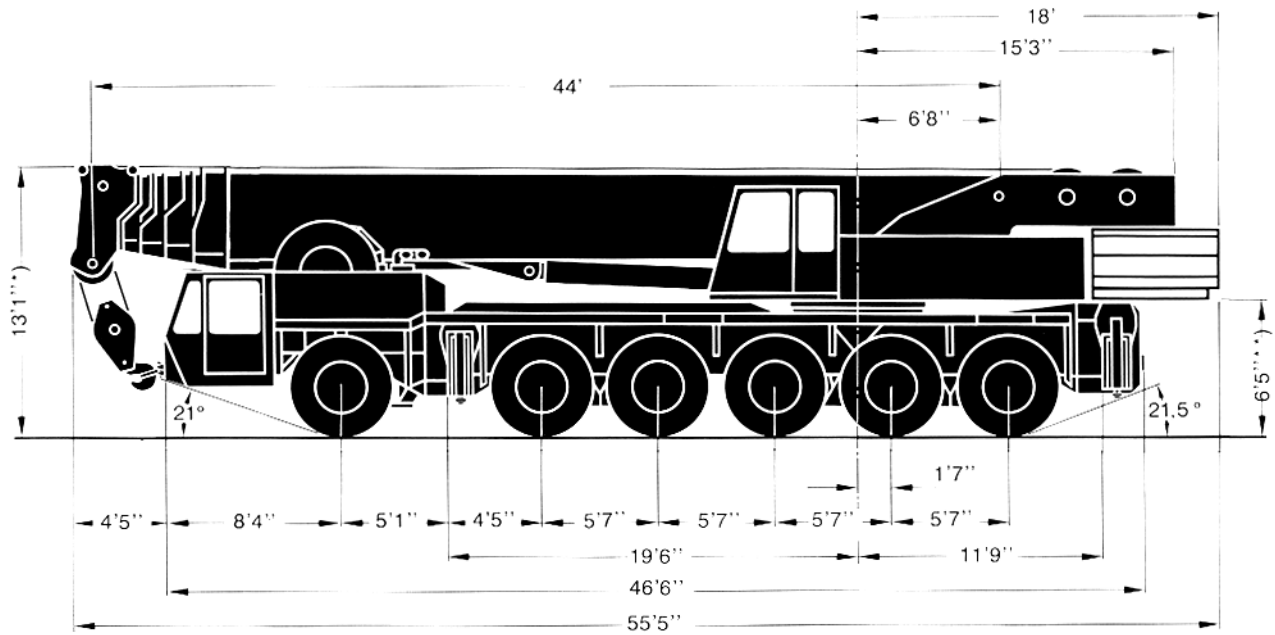

*) with 14.00 tires and quick disconnect: 13' 5"

**) with 14.00 tires and quick disconnect: 7'

