



LIFTING CHARTS - All Terrain Cranes

GROVE MODEL GMK6350 - 350 TON CAPACITY

## working range

### 51'-197' main boom

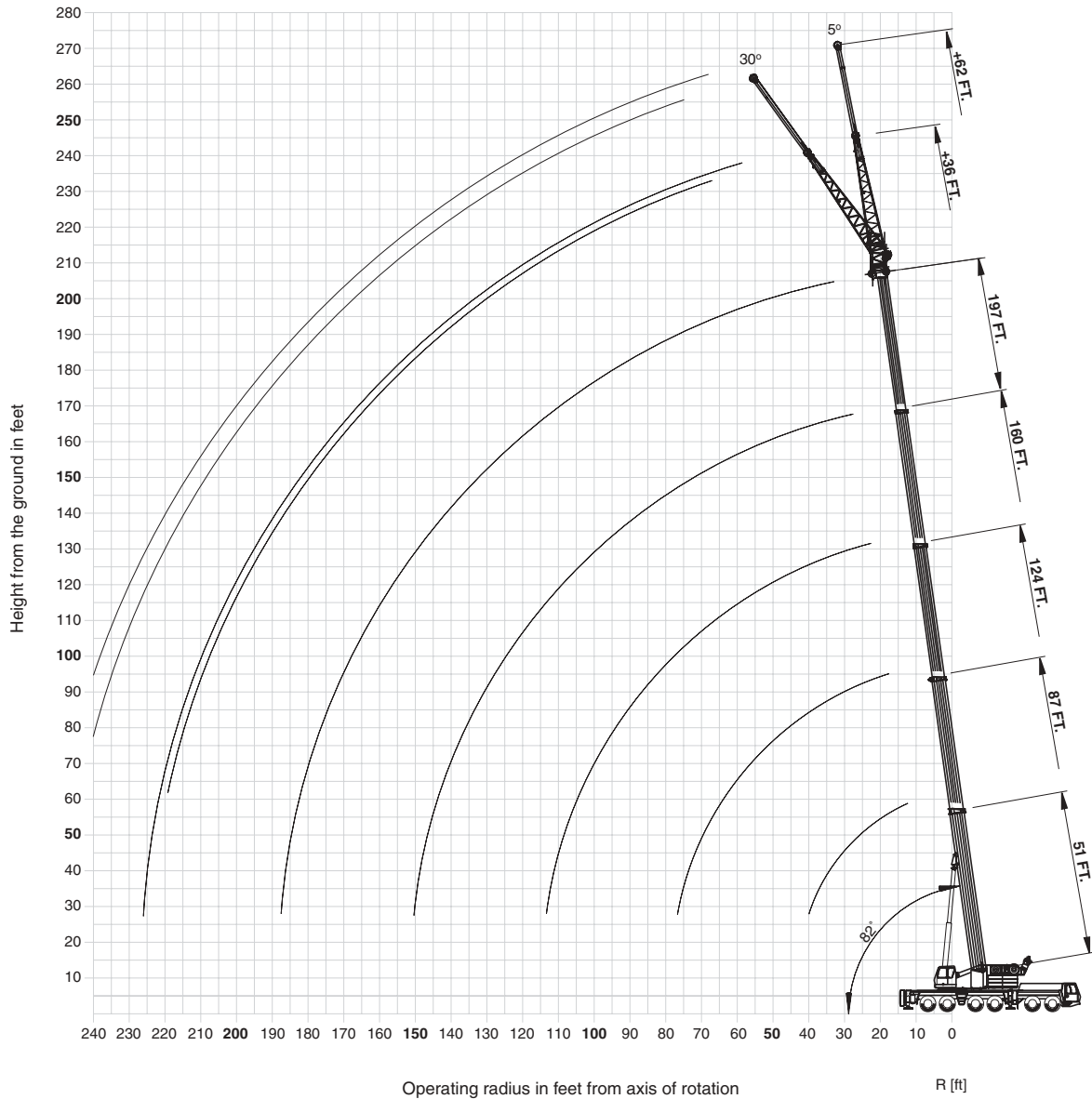

THIS CHART IS ONLY A GUIDE AND SHOULD NOT BE USED TO OPERATE THE CRANE.  
The individual crane's load chart, operating instructions and other instructional plates must be read and understood prior to operating the crane.

# STERLING CRANE

## load charts

Feet	51*	51	69	87	106	124	142	160	178	197
8	700.0†									
10	542.0	466.0	422.0	342.0						
15	412.0	370.0	366.0	342.0	242.0					
20	332.0	302.0	302.0	300.0	242.0	185.0	139.0			
25	266.0	254.0	258.0	254.0	242.0	185.0	139.0	106.0		
30	219.0	218.0	222.0	222.0	220.0	185.0	139.0	106.0	78.0	66.0
35	185.0	185.0	188.0	188.0	187.0	174.0	137.0	106.0	78.0	66.0
40			162.0	163.0	161.0	161.0	126.0	106.0	78.0	66.0
45			142.0	143.0	141.0	144.0	116.0	102.0	78.0	66.0
50			126.0	126.0	128.0	128.0	106.0	95.0	78.0	66.0
55			113.0	113.0	116.0	114.0	98.0	88.0	78.0	66.0
60				102.0	105.0	103.0	91.0	82.0	75.0	66.0
65				92.0	95.0	93.0	84.0	76.0	70.0	65.0
70				85.0	86.0	85.0	78.0	71.0	66.0	62.0
75					79.0	77.0	73.0	66.0	62.0	59.0
80					72.0	70.0	67.0	62.0	58.0	56.0
85					67.0	65.0	64.0	58.0	54.0	52.0
90					62.0	60.0	61.0	54.0	50.0	49.0
95						55.0	57.0	50.0	47.0	46.0
100						51.0	53.0	48.0	45.0	43.4
105						47.0	50.0	45.0	42.4	41.0
110						45.0	46.0	42.4	40.2	39.0
115							43.2	40.4	38.2	37.0
120							40.6	38.6	36.2	35.2
125								37.0	34.4	33.6
130								34.6	32.6	32.0
135								33.4	31.2	30.0
140								32.4	30.0	27.8
145									28.8	26.0
150									27.2	24.8
155									25.6	23.8
160									24.4	22.6
165										21.8
170										20.6
175										19.2
180										17.2

\* Over rear only, 28'6" x 19'8" outrigger base.      Lifting capacities greater than 425,000 lbs require additional equipment.      † 700,00 lbs is a comparative rating

Feet	51	69	87	106	124	142	160	178	197
10	446.0	422.0	342.0						
15	352.0	352.0	342.0	242.0					
20	278.0	282.0	282.0	242.0	185.0	139.0			
25	222.0	224.0	224.0	224.0	185.0	139.0	106.0		
30	180.0	183.0	183.0	182.0	182.0	139.0	106.0	78.0	66.0
35	147.0	150.0	151.0	155.0	150.0	137.0	106.0	78.0	66.0
40		129.0	131.0	130.0	126.0	118.0	106.0	78.0	66.0
45		111.0	113.0	112.0	108.0	102.0	97.0	78.0	66.0
50		95.0	97.0	97.0	94.0	94.0	87.0	78.0	66.0
55		81.0	83.0	83.0	82.0	83.0	79.0	73.0	66.0
60			73.0	72.0	75.0	73.0	70.0	68.0	66.0
65			64.0	63.0	66.0	64.0	64.0	63.0	59.0
70			57.0	59.0	59.0	57.0	58.0	56.0	53.0
75				54.0	53.0	52.0	52.0	51.0	48.0
80				48.0	48.0	48.0	47.0	46.0	43.0
85				43.8	42.8	43.6	42.6	41.2	39.0
90				39.6	38.8	39.6	38.4	37.0	35.4
95					36.2	36.0	34.8	33.4	31.8
100					33.0	32.8	31.6	30.2	28.6
105					30.0	29.8	28.8	27.4	25.6
110					27.6	27.4	26.2	24.8	23.2
115						25.0	23.8	22.6	20.8
120						23.0	21.8	20.4	18.8
125							19.8	18.6	16.8
130							18.2	16.8	15.0
135							16.6	15.2	13.4
140							15.0	13.8	12.0
145								12.4	10.6
150								11.2	9.4
155								10.0	8.2
160								9.0	7.0
165									6.0
170									5.0
175									4.2

Lifting capacities greater than 425,000 lbs require additional equipment.      Note: Above chart is available with reduced outriggers

# STERLING CRANE

## load charts

Pounds (thousands)

Feet	179 FT MAIN BOOM				197 FT MAIN BOOM			
	36 FT		62 FT		36 FT		62 FT	
	5°	30°	5°	30°	5°	30°	5°	30°
40	45.0		19.0		38.8		18.4	
45	43.6		18.4		38.8		18.2	
50	42.8	32.6	17.6		38.8	30.8	17.6	
55	42.0	31.8	17.0		38.4	30.4	17.0	
60	41.2	31.0	16.2		37.8	30.2	16.2	
65	40.4	30.4	15.6		37.4	29.8	15.8	
70	39.6	29.8	15.0	10.0	36.8	29.6	15.2	
75	39.0	29.2	14.4	9.8	36.4	29.2	14.6	9.8
80	38.2	28.6	14.0	9.6	35.8	28.6	14.2	9.6
85	37.6	28.0	13.6	9.4	35.4	28.2	13.8	9.4
90	36.8	27.6	13.0	9.2	34.4	27.6	13.2	9.4
95	36.0	26.8	12.6	9.2	34.0	27.0	13.0	9.2
100	35.2	25.8	12.2	9.0	34.0	26.0	12.6	9.0
105	34.4	24.8	11.8	8.8	33.6	25.0	12.2	8.8
110	33.4	24.6	11.6	8.6	33.0	24.6	11.8	8.8
115	32.6	24.2	11.2	8.6	32.6	24.4	11.6	8.6
120	31.6	23.8	11.0	8.4	32.0	24.0	11.2	8.6
125	30.8	23.6	10.6	8.4	31.0	23.8	11.0	8.4
130	30.0	23.4	10.4	8.2	30.2	23.6	10.6	8.4
135	28.6	23.2	10.2	8.2	28.6	23.4	10.4	8.2
140	27.2	23.0	10.0	8.0	26.8	23.0	10.2	8.2
145	25.8	22.8	9.6	8.0	25.2	22.8	10.0	8.0
150	24.6	22.6	9.4	7.8	24.2	22.8	9.8	8.0
155	23.6	22.4	9.2	7.8	23.0	22.6	9.6	7.8
160	22.4	22.2	9.0	7.8	22.2	22.2	9.4	7.8
165	21.0	21.6	8.8	7.6	21.2	21.6	9.2	7.8
170	20.2	20.4	8.8	7.6	20.2	20.8	9.0	7.6
175	19.4	19.8	8.6	7.6	19.0	20.0	8.8	7.6
180	18.8		8.4	7.6	17.8	18.6	8.6	7.6
185	18.2		8.2	7.4	16.6	17.2	8.6	7.6
190	17.4		8.2	7.4	15.4	16.0	8.4	7.6
195			8.0	7.4	14.2		8.2	7.4
200			7.8	7.4	13.2		8.2	7.4
205			7.8		12.4		8.0	7.4
210			7.6				8.0	7.4
215			7.6				7.8	7.4
220			7.6				7.8	7.4
225			7.4				7.6	
230							7.6	
235							7.4	
240							7.4	

Pounds (thousands)

Feet	179 FT MAIN BOOM				197 FT MAIN BOOM			
	36 FT		62 FT		36 FT		62 FT	
	5°	30°	5°	30°	5°	30°	5°	30°
40	45.0		19.0		38.8		18.4	
45	43.6		18.4		38.8		18.2	
50	42.8	32.6	17.6		38.8	30.8	17.6	
55	42.0	31.8	17.0		38.4	30.4	17.0	
60	41.2	31.0	16.2		37.8	30.2	16.2	
65	40.4	30.4	15.6		37.4	29.8	15.8	
70	39.6	29.8	15.0	10.0	36.8	29.6	15.2	
75	39.0	29.2	14.4	9.8	36.4	29.2	14.6	9.8
80	38.2	28.6	14.0	9.6	35.8	28.6	14.2	9.6
85	36.8	28.0	13.6	9.4	35.4	28.2	13.8	9.4
90	36.0	27.6	13.0	9.2	33.6	27.6	13.2	9.4
95	33.8	26.8	12.6	9.2	30.6	27.0	13.0	9.2
100	30.8	25.8	12.2	9.0	27.8	26.0	12.6	9.0
105	27.8	24.8	11.8	8.8	25.2	25.0	12.2	8.8
110	25.2	24.6	11.6	8.6	23.0	24.6	11.8	8.8
115	23.0	24.0	11.2	8.6	20.8	23.2	11.6	8.6
120	20.8	22.6	11.0	8.4	18.8	21.0	11.2	8.6
125	18.8	20.6	10.6	8.4	16.8	18.8	11.0	8.4
130	17.0	18.6	10.4	8.2	15.0	17.0	10.6	8.4
135	15.4	17.0	10.2	8.2	13.4	15.2	10.4	8.2
140	14.0	15.4	10.0	8.0	12.0	13.6	10.2	8.2
145	12.6	13.8	9.6	8.0	10.6	12.2	10.0	8.0
150	11.2	12.4	9.4	7.8	9.2	10.8	9.8	8.0
155	10.0	11.2	9.2	7.8	8.0	9.4	9.6	7.8
160	9.0	10.0	9.0	7.8	7.0	8.2	9.4	7.8
165	8.0	8.8	8.8	7.6	6.0	7.0	9.2	7.8
170	7.0	7.8	8.6	7.6	5.0	6.0	8.2	7.6
175	6.0	6.8	8.6	7.6	4.0	5.0	7.2	7.6
180	5.2		8.2	7.6	3.2	4.0	6.4	7.6
185	4.4		7.4	7.4		3.2	5.6	7.2
190	3.6		6.6	7.4			4.8	6.4
195			5.8	7.0			4.0	5.6
200			5.2	6.2			3.4	4.6
205			4.4				2.6	3.8
210			3.8					3.2
215			3.2					
220			2.6					

## working range – MEGALIFT

### 142'-197' MEGAWING lift

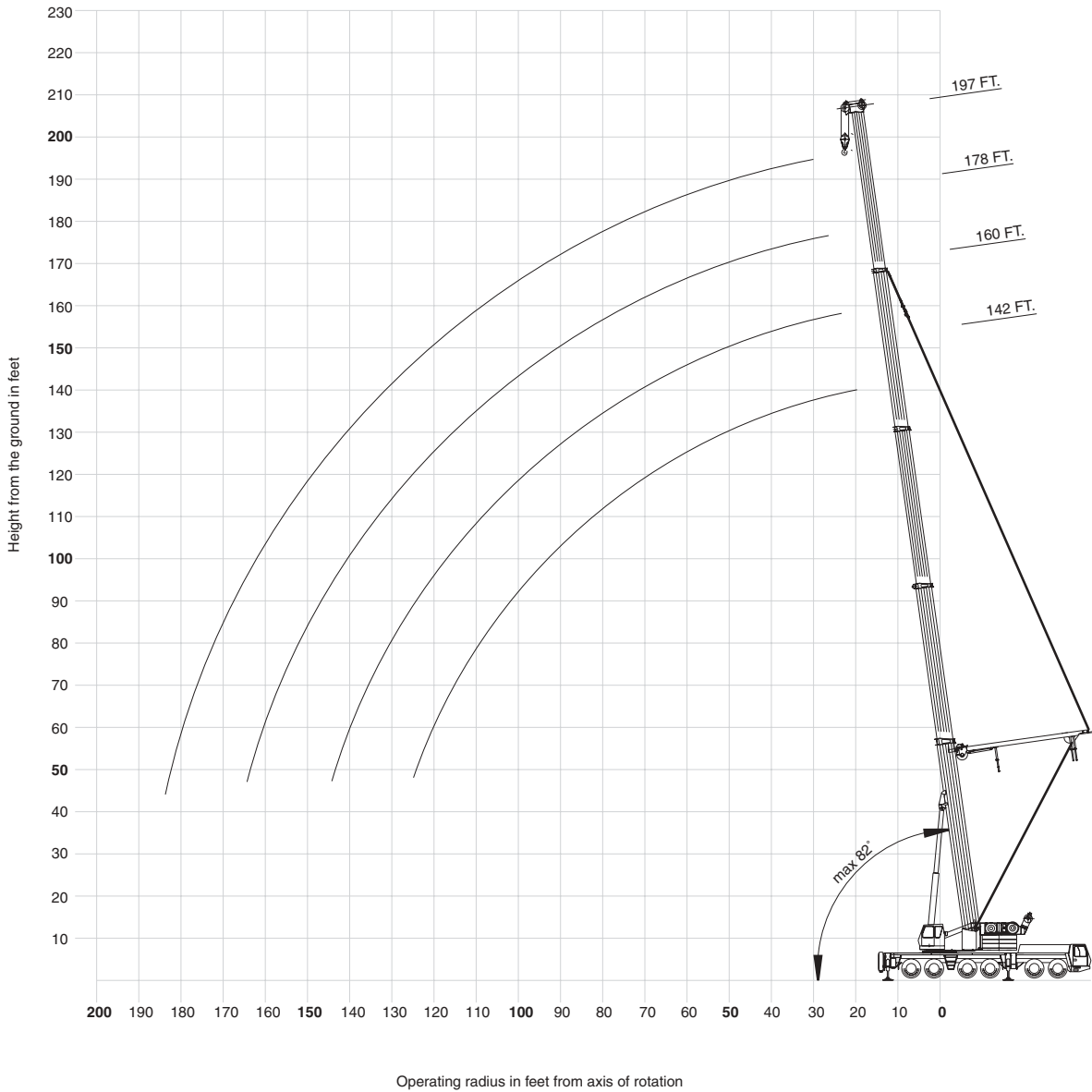

# STERLING CRANE

## load charts

 51-197 ft.  
(15.5-60.0 m)

 220,400 lbs.  
(100 Tonnes)

 100%  
27' 11" Spread

 360°

		Pounds (thousands)			
Feet	142	160	178	197	
20	139.0				
25	139.0	106.0			
30	139.0	106.0	78.0	66.0	
35	139.0	106.0	78.0	66.0	
40	139.0	106.0	78.0	66.0	
45	139.0	106.0	78.0	66.0	
50	126.0	106.0	78.0	66.0	
55	112.0	106.0	78.0	66.0	
60	100.0	101.0	78.0	66.0	
65	91.0	91.0	78.0	66.0	
70	82.0	83.0	78.0	66.0	
75	75.0	77.0	76.0	66.0	
80	71.0	71.0	70.0	66.0	
85	66.0	66.0	64.0	65.0	
90	63.0	62.0	59.0	60.0	
95	59.0	58.0	56.0	56.0	
100	55.0	54.0	53.0	52.0	
105	51.0	50.0	49.0	48.0	
110	47.0	47.0	46.0	44.0	
115	44.0	43.4	42.6	41.2	
120	41.4	40.6	39.8	38.4	
125		38.0	37.0	35.8	
130		35.6	34.6	33.4	
135		33.4	32.4	31.0	
140		31.2	30.4	29.0	
145			28.4	27.0	
150			26.6	25.2	
155			25.0	23.6	
160			23.4	22.0	
165				20.6	
170				19.2	
175				17.8	
180				14.4	

 51-197 ft.  
(15.5-60.0 m)

 110,200 lbs.  
(50 Tonnes)

 100%  
27' 11" Spread

 360°

		Pounds (thousands)			
Feet	142	160	178	197	
20	139.0				
25	139.0	106.0			
30	139.0	106.0	78.0	66.0	
35	139.0	106.0	78.0	66.0	
40	122.0	106.0	78.0	66.0	
45	105.0	101.0	78.0	66.0	
50	96.0	95.0	78.0	66.0	
55	89.0	85.0	76.0	66.0	
60	78.0	75.0	72.0	66.0	
65	69.0	67.0	64.0	60.0	
70	61.0	60.0	57.0	54.0	
75	54.0	54.0	52.0	48.0	
80	49.0	48.0	47.0	43.6	
85	43.6	42.8	41.8	39.4	
90	39.4	38.6	37.4	35.6	
95	35.4	34.6	33.6	32.0	
100	32.0	31.2	30.2	28.6	
105	29.0	28.2	27.2	25.6	
110	26.2	25.4	24.4	23.0	
115	23.8	23.0	22.0	20.4	
120	21.6	20.8	19.8	18.2	
125		18.8	17.8	16.2	
130		16.8	15.8	14.4	
135		15.2	14.2	12.6	
140		13.6	12.6	11.0	
145			11.2	9.6	
150			9.8	8.2	
155			8.6	7.0	
160			7.4	5.8	
165				4.8	
170				3.8	

## working range

### 51'-197' main boom

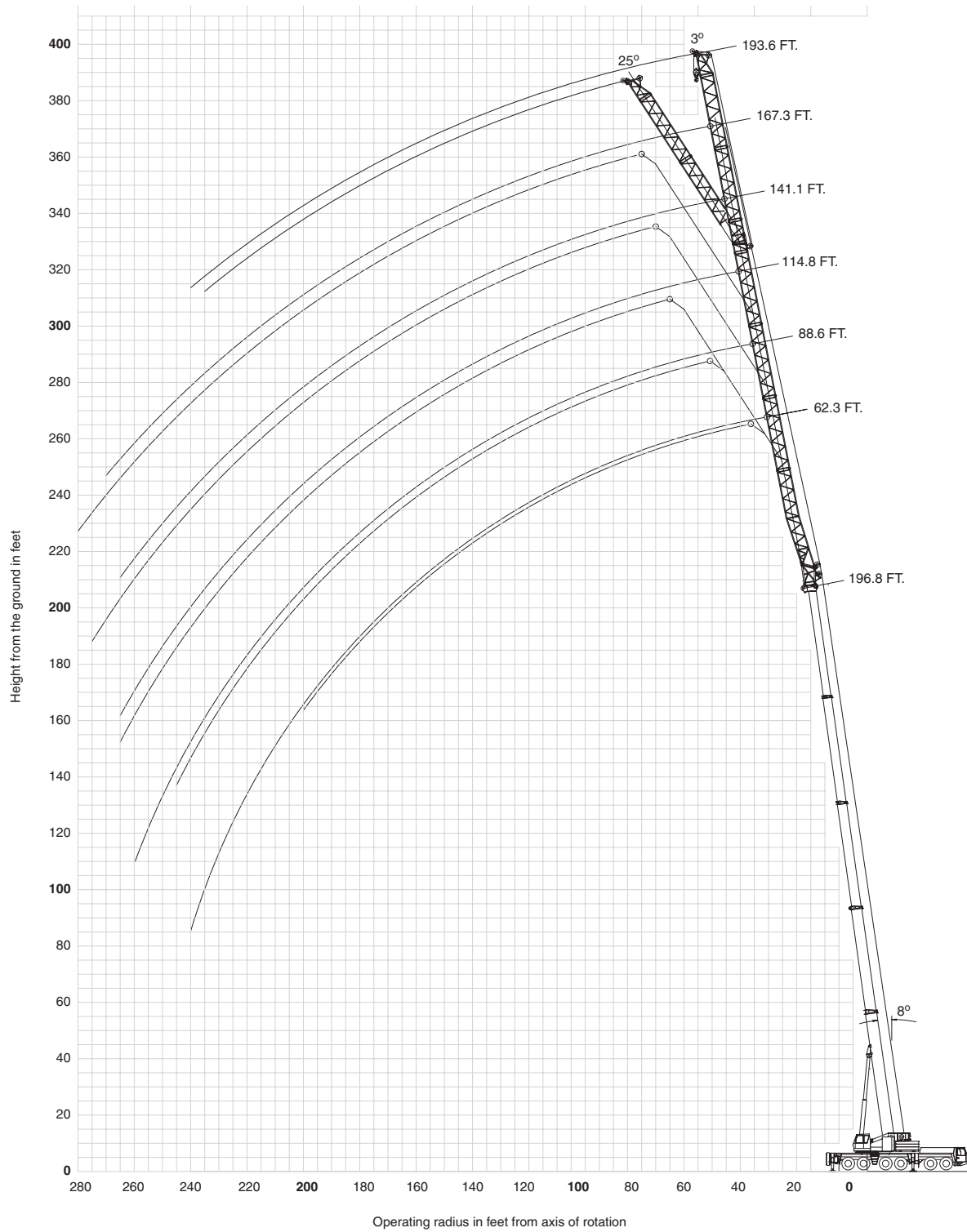

# STERLING CRANE

## load charts



Feet	Pounds (thousands)											
	62 FT		89 FT		115 FT		141 FT		167 FT		194 FT	
	3°	25°	3°	25°	3°	25°	3°	25°	3°	25°	3°	
35												
40												
45												
50	29.2											
55	29.2	28.6	21.2									
60	29.2	28.6	21.2		16.4							
65	29.2	28.6	21.2		16.4							
70	29.2	28.6	21.2		16.4		11.6					
75	29.2	28.6	21.2	20.6	16.4		11.6		9.2			
80	29.2	28.6	21.2	20.6	16.4		11.6		9.2			4.8
85	29.2	28.6	21.2	20.6	16.4		11.6		9.2			4.8
90	29.2	28.6	21.2	20.6	16.4		11.6		9.2			4.8
95	28.6	27.8	21.2	20.6	16.4	16.2	11.6		9.2			4.8
100	27.6	26.8	21.2	20.2	16.4	16.2	11.6		9.2			4.8
105	26.4	25.4	20.8	19.6	16.4	16.2	11.6	12.2	9.2			4.8
110	25.4	23.8	20.2	19.0	16.4	15.6	11.6	12.2	9.2			4.8
115	24.2	22.8	19.6	18.4	16.2	15.2	11.6	12.2	9.2	9.4		4.8
120	23.0	22.0	19.0	17.8	15.6	14.6	11.6	12.2	9.2	9.4		4.8
125	21.8	21.2	18.2	17.4	15.2	14.2	11.6	12.0	9.2	9.4		4.8
130	20.6	20.4	17.6	16.8	14.6	13.8	11.6	11.6	9.2	9.2		4.8
135	19.8	19.8	17.0	16.4	14.2	13.2	11.6	11.2	9.0	9.0		4.8
140	19.2	19.2	16.4	15.8	13.8	12.8	11.2	10.8	8.8	8.8		4.8
145	18.6	18.6	16.0	15.4	13.2	12.6	11.0	10.6	8.6	8.6		4.8
150	18.0	17.8	15.4	15.0	12.8	12.2	10.6	10.2	8.4	8.2		4.8
155	17.2	17.2	14.8	14.6	12.4	11.8	10.2	9.8	8.0	8.0		4.8
160	16.6	16.6	14.2	14.2	12.0	11.4	9.8	9.6	7.8	7.8		4.8
165	16.0	16.0	13.8	13.6	11.6	11.0	9.4	9.2	7.6	7.6		4.8
170	15.2	15.2	13.4	13.2	11.2	10.8	9.0	8.8	7.2	7.4		4.8
175	14.6	14.6	12.8	12.8	10.8	10.4	8.8	8.6	7.0	7.0		4.6
180	13.8	14.0	12.4	12.4	10.4	10.2	8.4	8.4	6.8	6.8		4.4
185	13.2	13.4	12.0	12.0	10.2	9.8	8.2	8.0	6.4	6.6		4.2
190	12.6	12.6	11.6	11.6	9.8	9.6	7.8	7.8	6.2	6.2		4.2
195	11.8	12.0	11.0	11.2	9.4	9.2	7.6	7.4	5.8	6.0		4.0
200	10.8	11.2	10.6	10.8	9.2	9.0	7.2	7.2	5.6	5.8		3.8
205	9.8	10.2	10.2	10.4	8.8	8.8	7.0	7.0	5.4	5.6		3.6
210	9.0	9.2	9.6	10.0	8.4	8.4	6.8	6.8	5.2	5.4		3.4
215	8.0	8.2	9.2	9.4	8.2	8.2	6.6	6.6	5.0	5.2		3.2
220	7.2	7.4	8.4	9.0	7.8	8.0	6.4	6.4	4.8	4.8		3.0
225	6.4		7.6	8.4	7.6	7.6	6.0	6.2	4.6	4.6		2.8
230	5.6		6.8	7.4	7.2	7.4	5.8	5.8	4.4	4.4		2.6
235	4.8		6.0	6.6	6.6	7.0	5.6	5.6	4.2	4.2		
240	3.8		5.2	5.8	6.0	6.8	5.4	5.4	4.0	4.2		
245			4.6	5.0	5.2	6.4	5.2	5.2	3.8	4.0		
250			4.0		4.6	5.6	4.8	5.0	3.6	3.8		
255			3.2		4.0	5.0	4.2	4.8	3.4	3.6		
260			2.6		3.4	4.2	3.6	4.6	3.2	3.4		
265					2.8	3.6	3.0	4.2	3.0	3.2		
270								3.6	2.6	3.0		
275								2.8		2.8		
280										2.6		



Feet	Pounds (thousands)											
	62 FT		89 FT		115 FT		141 FT		167 FT		194 FT	
	3°	25°	3°	25°	3°	25°	3°	25°	3°	25°	3°	
35												
40												
45												
50	29.2											
55	29.2	28.6	21.2									
60	29.2	28.6	21.2		16.4							
65	29.2	28.6	21.2		16.4							
70	29.2	28.6	21.2		16.4		11.6					
75	29.2	28.6	21.2	20.6	16.4		11.6		9.2			
80	29.2	28.6	21.2	20.6	16.4		11.6		9.2			4.8
85	29.2	28.6	21.2	20.6	16.4		11.6		9.2			4.8
90	29.2	28.6	21.2	20.6	16.4		11.6		9.2			4.8
95	27.8	27.8	21.2	20.6	16.4	16.2	11.6		9.2			4.8
100	25.0	26.4	21.2	20.2	16.4	16.2	11.6		9.2			4.8
105	22.6	23.8	20.8	19.6	16.4	16.2	11.6	12.2	9.2			4.8
110	20.2	21.4	20.2	19.0	16.4	15.6	11.6	12.2	9.2			4.8
115	18.0	19.2	19.0	18.4	16.2	15.2	11.6	12.2	9.2	9.4		4.8
120	16.0	17.2	17.2	17.8	15.6	14.6	11.6	12.2	9.2	9.4		4.8
125	14.2	15.4	15.4	17.4	15.2	14.2	11.6	12.0	9.2	9.4		4.8
130	12.6	13.6	13.8	16.4	14.0	13.8	11.6	11.6	9.2	9.2		4.8
135	11.0	12.0	12.2	14.6	12.4	13.2	11.6	11.2	9.0	9.0		4.8
140	9.6	10.4	10.8	13.0	11.0	12.8	11.0	10.8	8.8	8.8		4.8
145	8.2	9.0	9.4	11.6	9.8	12.6	9.8	10.6	8.6	8.6		4.8
150	7.0	7.8	8.2	10.2	8.4	12.0	8.4	10.2	8.4	8.2		4.8
155	5.8	6.4	7.0	9.0	7.4	10.6	7.4	9.8	7.2	8.0		4.8
160	4.6	5.2	5.8	7.6	6.2	9.4	6.2	9.4	6.0	7.8		4.8
165	3.6	4.2	4.8	6.6	5.2	8.2	5.2	8.2	5.0	7.6		4.4
170		3.2	3.8	5.4	4.2	7.0	4.2	7.2	4.2	7.0		3.6
175			2.8	4.4	3.2	6.0	3.4	6.2	3.2	6.0		2.6
180				3.4		5.0		5.2		5.0		
185						4.0		4.2		4.2		
190						3.0		3.2		3.2		

## working range

### 51'-160' main boom

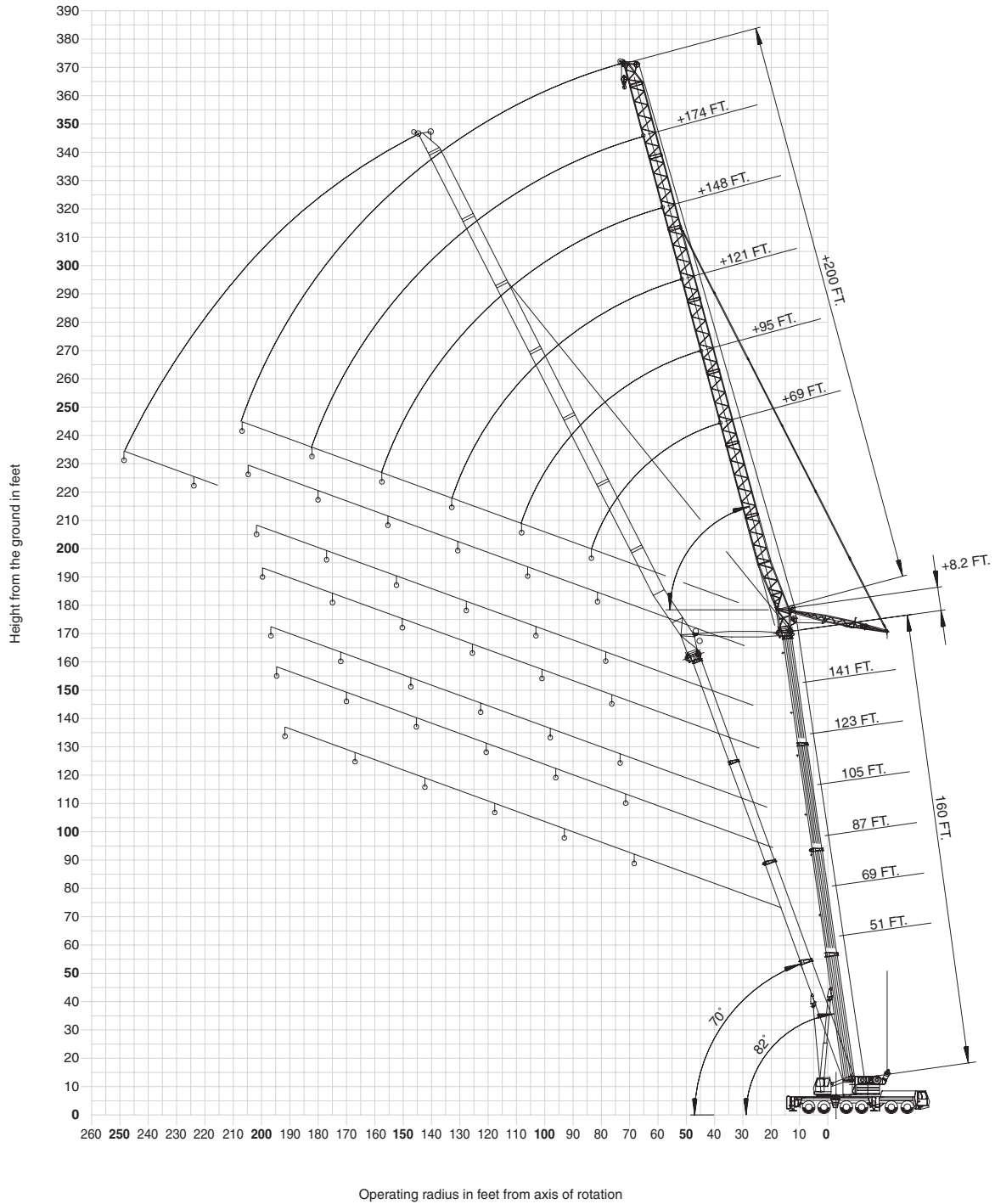



# STERLING CRANE

## load charts

 51-178 ft. (15.5-54.3 m)
  69 ft. (21 m)
  220,400 lbs. (100 Tonnes)
  100% 27' 11" Spread
  360°

		Pounds (thousands)						
		70° MAIN BOOM ANGLE						
Feet	51	69	87	105	123	141	160	178
55	115.0							
60	103.0							
65	89.0							
70	76.0	85.0						
75	65.0	79.0	75.0					
80		73.0	70.0					
85		61.0	66.0					
90			62.0	59.0				
95				55.0	51.0			
100					50.0	41.2		
105						41.2	33.0	
110						39.8	33.0	
115							32.4	27.4
120								27.0

 51-178 ft. (15.5-54.3 m)
  95 ft. (29 m)
  220,400 lbs. (100 Tonnes)
  100% 27' 11" Spread
  360°

		Pounds (thousands)						
		70° MAIN BOOM ANGLE						
Feet	51	69	87	105	123	141	160	178
70	84.0							
75	76.0							
80	68.0	73.0						
85	62.0	69.0						
90	55.0	65.0	61.0					
95	49.0	60.0	57.0					
100	43.4	54.0	54.0	51.0				
105		48.0	51.0	48.0	45.0			
110		42.0	48.0	46.0	43.6			
115			46.0	43.6	41.4	35.2		
120				41.4	39.4	34.8	28.0	
125					37.6	33.6	28.0	
130					35.8	32.6	27.0	
135						31.6	26.2	22.0
140							25.6	22.0
145								21.4
150								20.6

 51-178 ft. (15.5-54.3 m)
  121 ft. (37 m)
  220,400 lbs. (100 Tonnes)
  100% 27' 11" Spread
  360°

		Pounds (thousands)						
		70° MAIN BOOM ANGLE						
Feet	51	69	87	105	123	141	160	178
80	61.0							
85	59.0							
90	58.0							
95	54.0	55.0						
100	50.0	54.0	49.0					
105	46.0	53.0	49.0	42.8				
110	42.2	49.0	47.0	42.8				
115	38.2	46.0	45.0	42.8	36.2			
120	34.6	41.6	42.8	40.6	36.2	28.2		
125	31.0	38.0	40.8	38.8	36.2	28.2		
130	27.4	34.2	39.0	37.0	34.8	28.2		
135		30.2	37.2	35.4	33.2	28.2	21.6	
140			33.6	33.8	31.8	28.0	21.6	
145				32.4	30.4	27.4	21.6	16.0
150				31.0	29.2	26.8	21.6	16.0
155					28.0	26.2	21.4	16.0
160						25.2	21.0	16.0
165							20.4	15.8
170							19.8	15.6
175								15.4

# STERLING CRANE

## load charts

51-178 ft. (15.5-54.3 m)
 148 ft. (45 m)
 220,400 lbs. (100 Tonnes)
 100% 27' 11" Spread
 360°

Feet	70° MAIN BOOM ANGLE							
	51	69	87	105	123	141	160	178
95	42.6							
100	42.4							
105	41.8	38.8						
110	41.2	38.6						
115	39.6	38.4	34.8					
120	37.4	38.0	34.8	30.6				
125	35.4	37.6	34.6	30.6	26.4			
130	32.8	36.2	34.4	30.6	26.4			
135	30.4	34.6	34.4	30.4	26.4			
140	27.8	32.6	33.8	30.4	26.4	20.8		
145	25.4	30.4	33.0	30.4	26.4	20.8	15.2	
150	23.2	27.8	32.0	30.2	26.4	20.8	15.2	
155	20.8	25.4	30.0	28.8	26.2	20.6	15.2	
160		23.0	27.4	27.8	25.8	20.6	15.2	10.8
165			25.0	26.6	24.8	20.6	15.2	10.8
170			22.8	25.6	23.8	20.6	15.2	10.8
175				24.6	23.0	20.6	15.2	10.8
180					22.0	20.2	15.2	10.8
185						19.4	15.2	10.8
190							15.2	10.8
195							15.2	10.8
200								10.8

51-178 ft. (15.5-54.3 m)
 174 ft. (53 m)
 220,400 lbs. (100 Tonnes)
 100% 27' 11" Spread
 360°

Feet	70° MAIN BOOM ANGLE							
	51	69	87	105	123	141	160	178
105	29.4							
110	28.6							
115	28.0							
120	27.4	26.6						
125	26.8	25.8	24.6					
130	26.2	24.8	24.2					
135	25.2	24.2	23.6	21.6				
140	24.4	23.8	23.2	21.6	18.8			
145	23.6	23.4	22.8	21.4	18.8			
150	23.0	22.8	22.4	21.2	18.8			
155	22.4	22.4	22.0	20.8	18.6	14.6		
160	21.6	21.8	21.4	20.6	18.6	14.6	10.4	
165	20.0	21.4	21.2	20.2	18.4	14.6	10.4	
170	18.4	21.0	20.8	19.8	18.4	14.6	10.4	
175	17.0	19.8	20.4	19.6	18.2	14.6	10.4	6.6
180	15.6	18.4	19.8	19.2	17.8	14.6	10.4	6.6
185		16.8	18.8	18.8	17.8	14.6	10.4	6.6
190		15.6	17.8	18.6	17.6	14.6	10.4	6.6
195			17.0	18.4	17.4	14.6	10.4	6.6
200				18.0	17.0	14.6	10.4	6.6
205					16.8	14.4	10.4	6.6
210							10.4	6.6
215							10.4	6.6
220								6.6

51-160 ft. (15.5-48.6 m)
 200 ft. (61 m)
 220,400 lbs. (100 Tonnes)
 100% 27' 11" Spread
 360°

Feet	70° MAIN BOOM ANGLE						
	51	69	87	105	123	141	160
120	17.2						
125	16.4						
130	15.8						
135	15.4	16.0					
140	14.8	15.4	15.8				
145	14.4	15.0	15.2	14.8			
150	14.0	14.4	14.8	14.8			
155	13.6	14.0	14.2	14.4	12.6		
160	13.0	13.6	14.0	14.0	12.6		
165	12.6	13.2	13.4	13.6	12.6	9.8	
170	12.2	12.6	13.0	13.2	12.6	9.8	
175	11.8	12.2	12.8	12.8	12.4	9.8	6.0
180	11.6	12.0	12.4	12.4	12.2	9.6	6.0
185	11.4	11.6	12.0	12.0	12.0	9.4	6.0
190	11.0	11.2	11.8	11.8	12.0	9.4	6.0
195	10.8	11.0	11.4	11.4	11.6	9.4	6.0
200	10.6	10.6	11.0	11.0	11.2	9.4	6.0
205	10.2	10.4	11.0	11.0	11.0	9.4	6.0
210		10.2	10.6	10.6	10.8	9.4	6.0
215		10.0	10.4	10.4	10.4	9.4	6.0
220			10.2	10.2	10.2	9.4	6.0
225				10.0	10.0	9.4	6.0
230					9.8	9.2	6.0
235					9.6	9.2	6.0
240						9.0	6.0

# STERLING CRANE

## load charts

 51-178 ft. (15.5-54.3 m)
  69 ft. (21 m)
  220,400 lbs. (100 Tonnes)
  100% 27' 11" Spread
  360°

		Pounds (thousands)						
		82° MAIN BOOM ANGLE						
Feet	51	69	87	105	123	141	160	178
30	121.0							
35	121.0	114.0						
40	119.0	114.0	99.0	84.0				
45	103.0	114.0	99.0	84.0	67.0			
50	88.0	102.0	99.0	84.0	67.0	51.0	37.8	
55	75.0	88.0	96.0	84.0	67.0	51.0	37.8	29.2
60	63.0	74.0	88.0	84.0	67.0	51.0	37.8	29.2
65	52.0	62.0	74.0	84.0	67.0	51.0	37.8	29.2
70		50.0	61.0	74.0	67.0	51.0	37.8	29.2
75					67.0	51.0	37.8	29.2
80							37.8	29.2
85							37.8	29.2

 51-178 ft. (15.5-54.3 m)
  95 ft. (29 m)
  220,400 lbs. (100 Tonnes)
  100% 27' 11" Spread
  360°

		Pounds (thousands)						
		82° MAIN BOOM ANGLE						
Feet	51	69	87	105	123	141	160	178
40	88.0	79.0						
45	88.0	79.0						
50	88.0	78.0	69.0	60.0				
55	84.0	78.0	69.0	60.0	49.0	37.8		
60	76.0	78.0	69.0	60.0	49.0	37.8	28.6	21.6
65	67.0	75.0	69.0	60.0	49.0	37.8	28.6	21.6
70	60.0	68.0	69.0	60.0	49.0	37.8	28.6	21.6
75	54.0	60.0	65.0	60.0	49.0	37.8	28.6	21.6
80	47.0	53.0	59.0	59.0	49.0	37.8	28.6	21.6
85	41.4	47.0	53.0	59.0	49.0	37.8	28.6	21.6
90	35.4	40.8	47.0	53.0	48.0	37.8	28.6	21.6
95			40.4	47.0	46.0	37.8	28.6	21.6
100					43.6	37.8	28.6	21.6
105							28.6	21.6
110							28.6	21.6

 51-178 ft. (15.5-54.3 m)
  121 ft. (37 m)
  220,400 lbs. (100 Tonnes)
  100% 27' 11" Spread
  360°

		Pounds (thousands)						
		82° MAIN BOOM ANGLE						
Feet	50.7	69	86.5	104.7	122.8	141.2	159.6	178.2
50	62.0	56.0						
55	62.0	56.0	50.0	43.0				
60	61.0	55.0	50.0	43.0	36.0	28.0		
65	61.0	55.0	49.0	43.0	36.0	28.0		
70	59.0	55.0	49.0	43.0	36.0	28.0	21.4	15.8
75	56.0	55.0	49.0	42.8	36.0	28.0	21.4	15.8
80	53.0	54.0	49.0	42.8	36.0	28.0	21.4	15.8
85	48.0	51.0	49.0	42.8	36.0	28.0	21.4	15.8
90	44.0	48.0	49.0	42.6	36.0	28.0	21.4	15.8
95	40.0	45.0	47.0	42.6	36.0	28.0	21.4	15.8
100	36.2	40.6	43.8	42.4	36.0	28.0	21.4	15.8
105	32.4	36.4	40.6	42.4	36.0	28.0	21.4	15.8
110	29.0	32.6	36.6	39.0	36.0	28.0	21.4	15.8
115	25.6	28.8	32.8	35.6	36.0	28.0	21.4	15.8
120			28.6	32.2	35.4	28.0	21.4	15.8
125					32.0	28.0	21.4	15.8
130					28.6	28.0	21.4	15.8
135							21.4	15.8

# STERLING CRANE

## load charts

  
51-178 ft.  
(15.5-54.3 m)

  
148 ft.  
(45 m)

  
220,400 lbs.  
(100 Tonnes)

  
100%  
27' 11" Spread

  
360°

		Pounds (thousands)							
		82° MAIN BOOM ANGLE							
Feet	51	69	87	105	123	141	160	178	
50	43.8								
55	43.8	39.6							
60	43.6	39.6	35.8	31.0					
65	43.4	39.6	35.6	31.0					
70	43.2	39.2	35.6	31.0	26.6				
75	43.0	39.0	35.4	31.0	26.6	21.0	15.8	11.2	
80	42.6	39.0	35.2	30.8	26.6	21.0	15.8	11.2	
85	42.4	38.8	35.0	30.8	26.6	21.0	15.8	11.2	
90	42.0	38.4	35.0	30.6	26.6	21.0	15.8	11.2	
95	40.6	38.4	34.8	30.6	26.4	21.0	15.8	11.2	
100	38.6	37.8	34.6	30.6	26.4	21.0	15.8	11.2	
105	36.4	36.2	34.2	30.4	26.4	21.0	15.8	11.2	
110	33.6	34.8	33.6	30.4	26.4	21.0	15.8	11.2	
115	31.0	33.2	32.8	30.2	26.4	21.0	15.8	11.2	
120	28.4	31.4	32.4	30.0	26.2	21.0	15.8	11.2	
125	25.6	29.0	31.6	29.8	26.2	21.0	15.8	11.2	
130	23.4	26.2	29.2	28.2	26.0	21.0	15.8	11.2	
135	21.2	23.8	26.6	26.6	25.2	21.0	15.8	11.2	
140		21.4	24.2	24.8	24.2	21.0	15.8	11.2	
145			21.8	23.2	23.2	21.0	15.8	11.2	
150			18.8	21.4	22.0	21.0	15.8	11.2	
155					21.0	21.0	15.8	11.2	
160								11.2	

  
51-178 ft.  
(15.5-54.3 m)

  
174 ft.  
(53 m)

  
220,400 lbs.  
(100 Tonnes)

  
100%  
27' 11" Spread

  
360°

		Pounds (thousands)							
		82° MAIN BOOM ANGLE							
Feet	51	69	87	105	123	141	160	178	
60	31.6								
65	31.4								
70	31.0	28.2	25.8						
75	30.4	28.2	25.6	22.2	19.0				
80	30.2	28.0	25.4	22.0	19.0	14.4	10.6		
85	29.8	27.8	25.4	22.0	19.0	14.4	10.6		
90	29.4	27.4	25.2	21.8	19.0	14.4	10.6	6.8	
95	28.8	27.4	25.0	21.8	19.0	14.4	10.6	6.8	
100	28.4	27.0	24.6	21.8	19.0	14.4	10.6	6.8	
105	27.6	26.6	24.2	21.6	19.0	14.4	10.6	6.8	
110	26.8	26.0	24.0	21.4	18.8	14.4	10.6	6.8	
115	26.0	25.4	23.6	21.2	18.8	14.4	10.6	6.8	
120	25.4	24.4	23.0	21.2	18.8	14.4	10.6	6.8	
125	24.6	23.8	22.6	21.0	18.6	14.4	10.6	6.8	
130	23.8	23.4	22.4	20.8	18.6	14.4	10.6	6.8	
135	22.8	22.8	22.0	20.4	18.4	14.4	10.6	6.8	
140	22.0	22.2	21.4	20.2	18.4	14.4	10.6	6.8	
145	21.0	21.6	21.2	19.8	18.0	14.4	10.6	6.8	
150	19.2	20.4	20.6	19.6	17.8	14.4	10.6	6.8	
155	17.4	18.8	20.2	19.4	17.8	14.4	10.6	6.8	
160	15.6	17.4	19.2	19.0	17.6	14.4	10.6	6.8	
165		16.0	17.8	18.4	17.2	14.4	10.6	6.8	
170		14.2	16.0	17.2	16.6	14.4	10.6	6.8	
175			13.8	15.8	16.0	14.4	10.6	6.8	
180					15.2	14.4	10.6	6.8	
185							10.6	6.8	
190							10.6	6.8	

# STERLING CRANE

## load charts

 51-160 ft.  
(15.5-48.6 m)

 200 ft.  
(61 m)

 220,400 lbs.  
(100 Tonnes)

 100%  
27' 11" Spread

 360°



Pounds (thousands)

Feet	82° MAIN BOOM ANGLE						
	51	69	87	105	123	141	160
70	21.6	19.8					
75	21.2	19.8	17.8				
80	20.8	19.6	17.6	15.2	12.8		
85	20.4	19.4	17.6	15.2	12.8		
90	19.6	19.4	17.4	15.2	12.8	9.2	6.2
95	19.0	18.8	17.4	15.2	12.8	9.2	6.2
100	18.4	18.0	17.4	15.2	12.8	9.2	6.2
105	17.6	17.6	16.8	15.0	12.8	9.2	6.2
110	17.2	17.0	16.4	14.8	12.8	9.2	6.2
115	16.6	16.4	16.0	14.8	12.8	9.2	6.2
120	15.8	15.8	15.6	14.6	12.6	9.2	6.2
125	15.4	15.2	15.2	14.6	12.6	9.2	6.2
130	14.8	14.8	14.6	14.4	12.6	9.2	6.2
135	14.2	14.2	14.2	14.0	12.6	9.2	6.2
140	13.8	13.8	14.0	13.8	12.4	9.2	6.2
145	13.4	13.4	13.6	13.4	12.2	9.2	6.2
150	13.0	13.0	13.0	12.8	12.2	9.2	6.2
155	12.6	12.6	12.8	12.6	12.0	9.2	6.2
160	12.2	12.2	12.4	12.2	11.8	9.2	6.2
165	11.8	11.8	12.0	11.8	11.6	9.2	6.2
170	11.6	11.6	11.8	11.6	11.2	9.2	6.2
175	11.2	11.2	11.4	11.2	11.2	9.2	6.2
180	10.6	10.8	11.0	11.0	10.8	9.2	6.2
185	10.2	10.4	11.0	10.8	10.4	9.2	6.2
190	10.0	10.2	10.6	10.4	10.4	9.2	6.2
195		9.8	10.2	10.2	10.0	9.2	6.2
200				10.0	10.0	9.2	6.2
205						9.2	6.2
210							6.2
215							6.2

## specifications

### Superstructure

#### Boom

51 ft. - 197 ft. (15.5 m - 60 m) five section, full power MEGAFORM™ boom with patented TWIN-LOCK™ boom pinning system. Maximum tip height: 207 ft. (63 m).

#### Boom Elevation

Single lift cylinder with safety valve provides boom angle from -1.5° to +82°.

#### \* Telescopic Swingaway Extension

36 ft. - 62 ft. (11 m - 19 m) telescoping offsettable swingaway extension. Offsettable at 5° and 30°.

#### Lattice Jib

Luffing Jib is a lattice design with lengths of 69 ft. -200 ft. (21 m - 61m) in sections of 26 ft. (8 m). The luffing jib converts to a fixed offset lattice jib using an offset angle adapter and provides lengths of 62 ft. - 194 ft. (19 m - 59 m) offsettable at 3° and 25°.

#### MEGALIFT™ Attachment-Main Boom

Consists of a mast, pendant lines, and hydraulic tensioning winch to support the main boom during lifting operations. Load charts available for main boom only as optional equipment.

#### Load Moment & Anti-Two Block System

Load moment and anti-two block system with audio/visual warning and control lever lockout provides electronic display of boom angle, length, radius, tip height, relative load moment, maximum permissible load, load indication and warning of impending two-block condition.

#### Cab

All aluminum construction cab is tiltable (approximately 20°) and includes safety glass and adjustable operator's seat with hydraulic suspension. Other features include engine dependent hot water heater, armrest integrated crane controls, and ergonomically arranged instrumentation.

#### Swing

3 axial piston fixed displacement motors provide swing speed of 0 - 1.6 RPM thru planetary gear box. Also provided is a spring applied, hydraulically released automatic swing brake with foot operated release for free swing.

#### Counterweight

220,400 lbs. (100 Tonnes) consisting of various sections with hydraulic installation/removal system (see counterweight configuration on page 17).

#### Engine

Mercedes-Benz OM906LA, diesel, 6 cylinders, water cooled, turbocharged, 275 HP (205 kW) at 1800 rpm.  
Max. torque: 811 ft./lbs. (1100 Nm) at 1300 rpm.  
Engine emission: EUROMOT/EPA/CARB.

#### Fuel Tank Capacity

87 gal. (330 L).

#### Hydraulic System

4 separate circuits, 3 axial piston variable displacement pumps with electronic power limiting control and 1 axial piston variable displacement pump for slewing. Standard thermostatically controlled oil cooler keeps oil at optimum operating temperature. Tank capacity: 322 gal. (1220 L)

#### Control System

Full electronic control of all crane movements is accomplished using electrical control levers with automatic reset to zero. Controls are integrated with the LMI and engine management system by CAN-BUS.

#### Hoist

Main and auxiliary hoist are powered by axial piston variable displacement motor with planetary gear and brake. "Thumb-thumper" hoist drum rotation indicator alerts operator of hoist movement.

	Main	Auxiliary
Line length:	984 ft. (300 m)	1,378 ft. (420 m)
Rope diameter:	24 mm	24 mm
Line speed:	460 ft./min. (140 m/min)	426 ft./min. (130 m/min)
Line pull:	24,700 lbs. (110 kN)	24,700 lbs. (110 kN)

#### Electrical System

24 V system with three-phase alternator 28 V/80 A, 2 batteries 12 V/170 Ah.

#### \* Optional Equipment

- \* Engine-independent diesel heater, with engine pre-heater
- \* Second spotlight
- \* Stereo/CD player
- \* Air Conditioning
- \* Stainless steel exhaust system
- \* MEGALIFT attachment
- \* Engine independent propane cab heater
- \* Auxiliary boom nose
- \* Boom mounted work lights
- \* Aircraft warning light
- \* 24 hr. timer for diesel heater

\* Denotes optional equipment

## specifications

### Carrier

#### Chassis

Box-type, torsion resistant frame is fabricated from high-strength steel.

#### Outrigger System

Hydraulic two-stage outrigger beams are extended by a single hydraulic cylinder and two cables. Outriggers can adjust to two positions:

- Fully extended (100%) - 27' 11" (8.5 m)
- Partially extended (50%) - 19' 8" (6 m)

Four 29.5 in. x 32 in. (750 mm x 810 mm), self stowing, steel outrigger pads provide rigid lifting base. Outrigger controls are located on both sides of the carrier. An electronic level indicator is located next to each outrigger control box.

#### Engine

Mercedes-Benz OM502LA, diesel, 8 cylinders, water-cooled, turbocharged, 563 HP (420 kW) at 1800 rpm.  
Max. torque: 1991 ft./lbs. (2700 Nm) at 1080 rpm.  
Engine emission: EPA/CARB.

#### Fuel Tank Capacity

132 gal. (500 L).

#### Transmission

Allison automatic CLT 755, 5 forward and 1 reverse speed. Transfer case with 2 speeds and inter-axle differential lock.

#### Drive/Steer

12 x 6 x 12.

#### Axles

6 axles. 1, 2, 4 and 5 are drive/steer. Axles 3 and 6 are steer only.

#### Suspension

GROVE GMK6350 features the Grove exclusive MEGATRAK™ suspension. This revolutionary design features an independent hydropneumatic system with hydraulic lockout acting on all wheels. The suspension can be raised 6-1/2" (170 mm) or lowered 5" (130 mm) both longitudinally and transversely and features an automatic leveling system for on-highway travel.

#### Tires

12 tires, 16.00 R25 (vehicle width 9 ft. 10 in.)

#### Steering

Dual circuit steering system is hydraulic power assisted with a transfer case mounted, ground driven, emergency steering pump. Axles 1, 2, 3, 5 and 6 steer on highway. Separate steering of the 4th, 5th and 6th axle for all wheel steer and crab-steer is controlled by an electric rocker switch.

#### Brakes

A dual circuit air system operates on all wheels with a spring-applied, air released parking brake acting on axles 2, 4, 5 and 6. An air dryer is fitted to remove moisture from the air system. Engine compression brake is standard.

#### Cab

Two-man, aluminum construction driver's cab includes the following features: safety glass; driver and passenger seats with hydraulic suspension, engine-dependent hot water heater, complete instrumentation and driving controls.

#### Electrical System

24 V system with three-phase alternator 28 V/80 A, 2 batteries 12 V/170 Ah.

#### Maximum Speed

48 mph (77km/h) with 16.00/20.5 tires.

#### Gradeability (theoretical)

46% with 20.5 R25 tires.

### Miscellaneous Standard Equipment

Boom removal kit; trailing boom kit (less dolly); additional hydraulic oil cooler; removable rear outrigger box; flashing amber warning light on carrier cab; working light; tool kit; fire extinguisher; radio cassette in carrier cab.

### \* Optional Equipment

- \* 12 x 8 x 12
- \* Electric driveline retarder
- \* 20.5 tires
- \* Outrigger pressure measurement devices
- \* Engine-independent hot water heater, with engine pre-heater
- \* Stainless steel exhaust system
- \* Trailing boom "boost" weight transfer kit
- \* Air conditioning
- \* Spare tire and wheel
- \* Worklights for outriggers
- \* Engine independent propane cab heater
- \* Rear mounted stowage box

\* Denotes optional equipment

## trailing boom proposal

### Trailing Boom

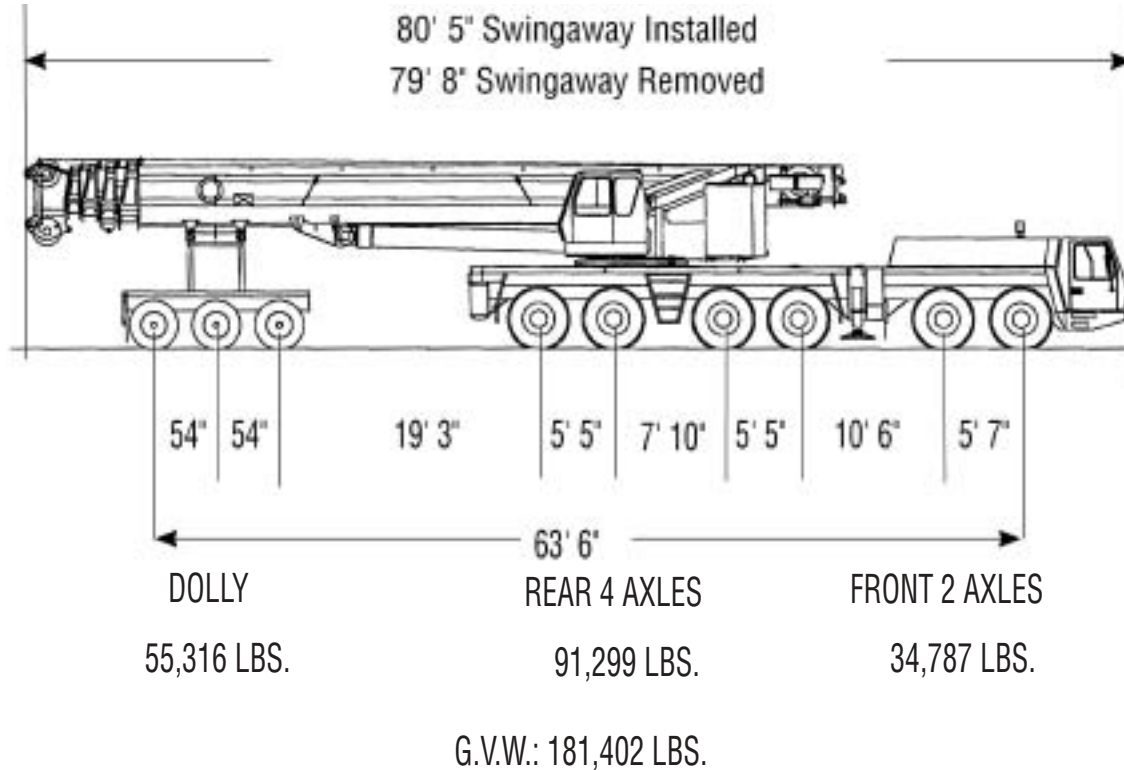

### UNIT EQUIPPED AS FOLLOWS:

Mercedes engines carrier and superstructure, outrigger pads in place, frame equipped for removable outrigger box, rear box in place, main & auxiliary hoist with rope, swingaway on boom, 3 axle boom dolly (7,600 LBS.), 16.0 tires, counterweight removed. 12 x 6 x 12 drive.

### Weight effects:

Component	Dolly	Rear Axles	Front Axles	Gross
Remove rear outrigger box	0	-17,555 lbs.	+6,753 lbs.	-10,802 lbs.
Remove front outrigger beams	0	-1,980 lbs.	-3,377 lbs.	-5,357 lbs.
Remove rear outrigger beams	0	-9,652 lbs.	+3,732 lbs.	-5,919 lbs.
Remove auxiliary hoist with rope	0	-2,134 lbs.	-3,951 lbs.	-6,085 lbs.
Remove swingaway	-5,205 lbs.	+99 lbs.	+35 lbs.	-5,071 lbs.
Add 12 x 8 x 12 Drive	0	-106 lbs.	+966 lbs.	+860 lbs.
Fixed MEGALIFT brackets w/o winch	547 lbs.	-13 lbs.	-4 lbs.	529 lbs.
Fixed bracket for MEGALIFT winch	170 lbs.	119 lbs.	42 lbs.	331 lbs.
Bolted parts for MEGALIFT	170 lbs.	119 lbs.	42 lbs.	331 lbs.
MEGALIFT winch	7,299 lbs.	3,468 lbs.	1,224 lbs.	11,993 lbs.

Note: Weights may vary 3% due to manufacturing tolerances.

THIS ILLUSTRATION IS ONLY A GUIDE. CONSULT FACTORY FOR SPECIFIC DETAILS.



# STERLING CRANE

## counterweight

- 1. 17,600 lbs. (8 Tonnes)
- 2. 30,900 lbs. (14 Tonnes)
- 3A. 15,450 lbs. (7 Tonnes)
- 3B. 15,450 lbs. (7 Tonnes)
- 4. 30,900 lbs. (14 Tonnes)
- 5. 33,000 lbs. (15 Tonnes)
- 6. 33,000 lbs. (15 Tonnes)
- 7. 22,050 lbs. (10 Tonnes)
- 8. 22,050 lbs. (10 Tonnes)

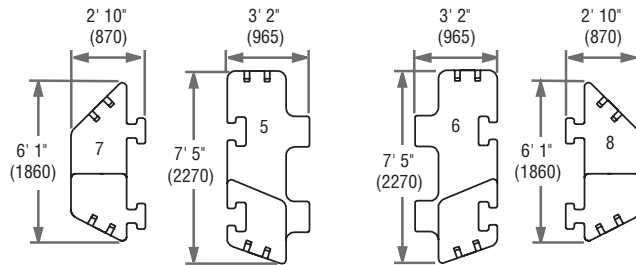
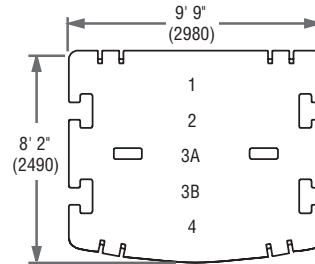
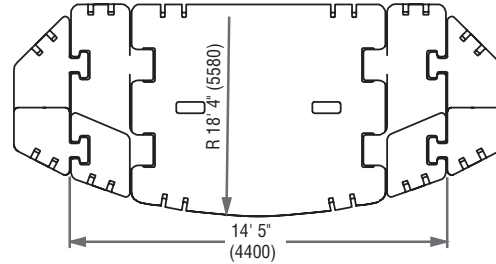
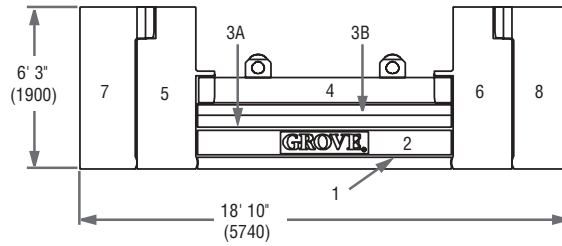

Note: ( ) Reference dimensions in mm

	1	2	3A	3B	4	5	6	7	8
17,600 lbs.	X								
48,500 lbs.	X	X							
79,300 lbs.	X	X	X	X					
110,200 lbs.	X	X	X	X	X				
176,300 lbs.	X	X	X	X	X	X	X		
220,400 lbs.	X	X	X	X	X	X	X	X	X

## rated lifting capacities

### IMPORTANT NOTES:

**WARNING: THIS CHART IS ONLY A GUIDE.** The notes below are for illustration only and should not be relied upon to operate the crane. The individual crane's load chart, operating instructions and other instruction plates must be read and understood prior to operating the crane.

1. All rated loads meet ANSI/ASME B30.5, Mobile and Locomotive Cranes. Testing and development were performed to SAEJ1063, Cantilevered Boom Crane Structures - Method of Test and SAEJ765 Crane Stability Test Code.

2. Capacities given do not include the weight of hook blocks, slings, auxiliary lifting equipment and load handling devices. Their weights must be added to the load to be lifted. When more than minimum required reeving is used, the additional rope weight shall be considered part of the load.

3. The machine shall be leveled on a firm supporting surface. Depending on the nature of the supporting surface, it may be necessary to have structural supports under the outrigger floats to spread the load to a larger bearing surface.

4. When either boom length or radius or both are between values listed, the smallest load shown at either the next larger radius or next longer or shorter boom length shall be used.

































5. For outrigger operation, outriggers shall be properly extended with tires raised off the ground before operating the boom or lifting loads.

### † Comparative Rating

A rating designation based upon the premise that large capacity European cranes are typically purchased and used as long boom, high reach, long radius lift cranes – not as heavy lift cranes.



To provide a GMK 6350 crane with the necessary equipment to achieve maximum lift capacity will drastically reduce long boom performance. Therefore, augmenting lifting equipment is required for buyers who require such capacities.



### Symbols Glossary

	Frame		Steering
	Outriggers		Transmission
	Outrigger Controls		Axles
	Engine		Brakes
	Fuel Tank Capacity		Tires
	Electrical System		Suspension
	Drive		Rotation
	Lights		Boom Elevation
	Cab		Swing
	Boom		Counterweight
	Boom Nose		Oil
	Boom Extension		Hydraulic System
	Speed		Hoist
	Grade		Radius
	Extension		Boom Length
	Gear		Hookblock

# STERLING CRANE



## overview of standard duty charts



 51 ft. - 197 ft.    
  360°

 28.5 x 27.9 ft.    
  28.5 x 19.7 ft.



ft.	Thousand lbs.	220.4	176.3	110.2	79.3	48.5	17.6	0	220.4	176.3	110.2	79.3	48.5	17.6	0
51		.	.	.	.	.	.	.	*	*	.	.	.	.	.
69		.	.	.	.	.	.	.	*	*	.	.	.	.	.
87		.	.	.	.	.	.	.	*	*	.	.	.	.	.
105		.	.	.	.	.	.	.	.	.	.	.	.	.	.
124		.	.	.	.	.	.	.	.	.	.	.	.	.	.
142		.	.	.	.	.	.	.	.	.	.	.	.	.	.
160		.	.	.	.	.	.	.	.	.	.	.	.	.	.
178		.	.	.	.	.	.	.	.	.	.	.	.	.	.
197		.	.	.	.	.	.	.	.	.	.	.	.	.	.

\* 0° over rear

 5°, 30°  
36 ft. - 59 ft.    
  360°

 28.5 x 27.9 ft.    
  28.5 x 19.7 ft.





ft.	Thousand lbs.	220.4	176.3	110.2	79.3	48.5	17.6	110.2	79.3	48.5
51		.	.	.	.	.	.	.	.	.
69		.	.	.	.	.	.	.	.	.
87		.	.	.	.	.	.	.	.	.
105		.	.	.	.	.	.	.	.	.
124		.	.	.	.	.	.	.	.	.
142		.	.	.	.	.	.	.	.	.
160		.	.	.	.	.	.	.	.	.
178		.	.	.	.	.	.	.	.	.
197		.	.	.	.	.	.	.	.	.

 3°, 25°  
62 ft. - 167 ft.    
  360°    
  28.5 x 27.9 ft.

Thousand lbs.

ft.	ft.	62	88	115	141	167	194(1)	62	88	115	141	167	194(1)	62	88	115	141	167	194(1)	62	88	115	141	167	62	88	115		
51		.	.	.	.	.	.	.	.	.	.	.	.	.	.	.	.	.	.	.	.	.	.	.	.	.	.	.	.
69		.	.	.	.	.	.	.	.	.	.	.	.	.	.	.	.	.	.	.	.	.	.	.	.	.	.	.	.
87		.	.	.	.	.	.	.	.	.	.	.	.	.	.	.	.	.	.	.	.	.	.	.	.	.	.	.	.
105		.	.	.	.	.	.	.	.	.	.	.	.	.	.	.	.	.	.	.	.	.	.	.	.	.	.	.	.
124		.	.	.	.	.	.	.	.	.	.	.	.	.	.	.	.	.	.	.	.	.	.	.	.	.	.	.	.
142		.	.	.	.	.	.	.	.	.	.	.	.	.	.	.	.	.	.	.	.	.	.	.	.	.	.	.	.
160		.	.	.	.	.	.	.	.	.	.	.	.	.	.	.	.	.	.	.	.	.	.	.	.	.	.	.	.
178		.	.	.	.	.	.	.	.	.	.	.	.	.	.	.	.	.	.	.	.	.	.	.	.	.	.	.	.
197		.	.	.	.	.	.	.	.	.	.	.	.	.	.	.	.	.	.	.	.	.	.	.	.	.	.	.	.

(1) 3° only

 69 ft. - 200 ft.    
  82° / 70°    
  28.5 x 27.9 ft.    
  360°

Thousand lbs.

ft.	ft.	69	95	121	147	174	200	69	95	121	147	174	200	69	95	121	147	174	200	69	95	121	147	174	200	69	95	121	147	174	200	
51		.	.	.	.	.	.	.	.	.	.	.	.	.	.	.	.	.	.	.	.	.	.	.	.	.	.	.	.	.	.	.
69		.	.	.	.	.	.	.	.	.	.	.	.	.	.	.	.	.	.	.	.	.	.	.	.	.	.	.	.	.	.	.
87		.	.	.	.	.	.	.	.	.	.	.	.	.	.	.	.	.	.	.	.	.	.	.	.	.	.	.	.	.	.	.
105		.	.	.	.	.	.	.	.	.	.	.	.	.	.	.	.	.	.	.	.	.	.	.	.	.	.	.	.	.	.	.
124		.	.	.	.	.	.	.	.	.	.	.	.	.	.	.	.	.	.	.	.	.	.	.	.	.	.	.	.	.	.	.
142		.	.	.	.	.	.	.	.	.	.	.	.	.	.	.	.	.	.	.	.	.	.	.	.	.	.	.	.	.	.	.
160		.	.	.	.	.	.	.	.	.	.	.	.	.	.	.	.	.	.	.	.	.	.	.	.	.	.	.	.	.	.	.
178		.	.	.	.	.	.	.	.	.	.	.	.	.	.	.	.	.	.	.	.	.	.	.	.	.	.	.	.	.	.	.

† Only with 82° boom angle.

# STERLING CRANE

## dimensions

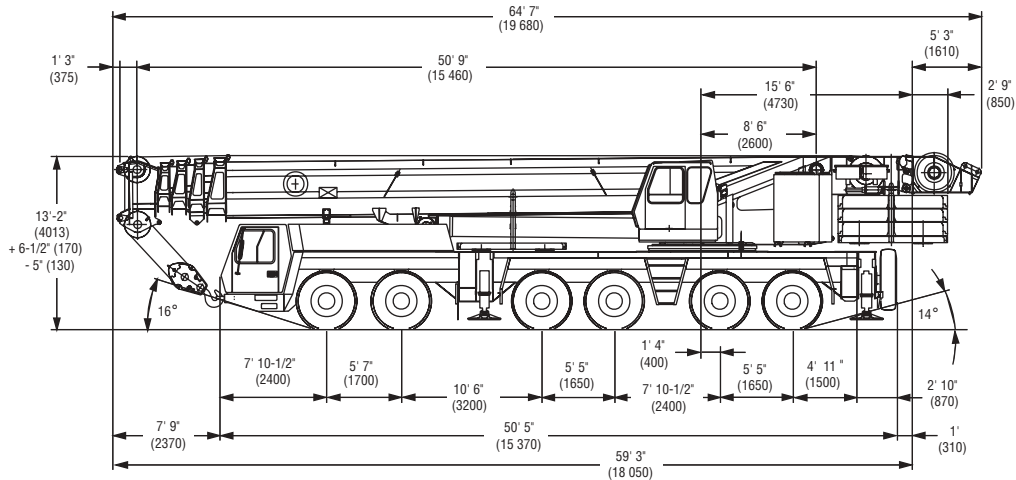
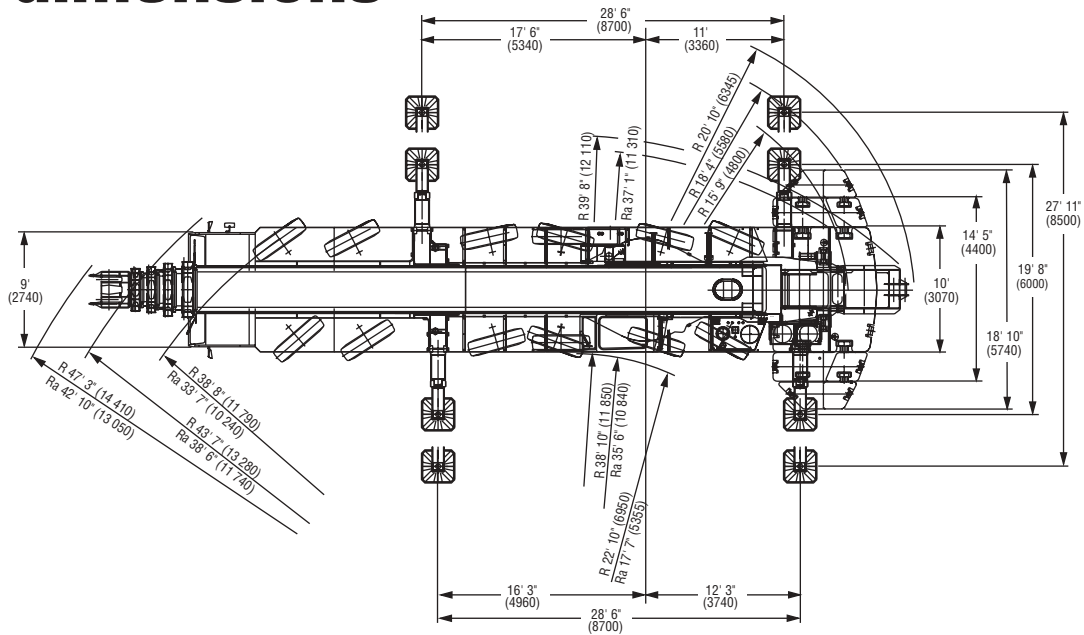

Note: ( ) Reference dimensions in mm

BASIC WEIGHTS (LBS.)	Axles 1 & 2	Axles 3 - 6	Total
Mercedes Power, 12x6, 20.5 R25 Tires, 2nd Hydraulic Oil Cooler, Brackets for swingaway	50,781	107,969	158,750
<b>Additions:</b>			
12 x 8 x 12 in lieu	965	-(105)	860
Outrigger Pads	-	772	772
Removable rear outrigger box option	-(1,225)	3,430	2,205
Auxiliary Hoist	-(5,365)	11,450	6,085
Swingaway	6,860	-(1,525)	5,335
Spare Wheel 20.5 with stowage	-(590)	1,400	810
Spare Wheel 16.00 with stowage	-(520)	1,240	720
Spare Wheel 14.00 with stowage	-(425)	1,010	585
Fixed MEGALIFT brackets w/o winch	653 lbs.	-123 lbs.	530 lbs.
Fixed bracket for MEGALIFT winch	119 lbs.	212 lbs.	331 lbs.
Bolted parts for MEGALIFT	119 lbs.	212 lbs.	331 lbs.
MEGALIFT winch	6,257 lbs.	5,736 lbs.	11,993 lbs.
<b>Removal:</b>			
Front Outrigger Beams & Jacks	-(3,380)	-(1,980)	-(5,360)
Rear Outrigger Beams & Jacks	3,730	-(9,650)	-(5,920)
Outrigger Box (must add weight above for option)	6,750	-(17,550)	-(10,800)
Boom Assembly (minus lift cylinder)	-(34,750)	-(23,175)	-(57,925)
Telescope Sections 1-4	-(27,900)	-(15,860)	-(43,760)
Lift Cylinder	-(2,250)	-(3,400)	-(5,650)
16.00 R25 Tires in lieu	-(370)	-(740)	-(1,110)
14.00 R25 Tires in lieu	-(900)	-(1,800)	-(2,700)